



捷波資訊股份有限公司
JETWAY INFORMATION CO., LTD.



2020/2021

Embedded Computing System Selection Guide



捷波資訊股份有限公司
JETWAY INFORMATION CO., LTD.

Introduction



Genuine and Trusty, Professional Jetway

Jetway Information Co., Ltd. was established in Taipei, Taiwan 1986, is a world-leading innovator and manufacturer, by providing wide-range PC peripheral solutions and services to meet customers' needs.

Jetway entered the Industrial PC market in 2005 by developing Single-Board Computers and non-PC platforms with our expertise, Jetway has built a well-known reputation at IPC markets. Jetway IPC solution products has been successfully phased-in to several applications: points of sales (POS), Kiosk and Digital signage, Surveillance system, Industrial Automation, Health Care Terminals, Gaming and Amusement Industrial, Residential control, Transportation, Military, In-Car System, Tele- Communication, Banking/ATM, Storage...etc.



Dedicated in Perfection, and Creative Jetway!

More than 100 highly qualified engineers support with our experienced sales teams, global business units and partners to create solutions that meet our customer's application demand, Jetway's product longevity, professional engineering, fast support, and value-added services, helps create a sustainable and viable embedded solution for OEMs and system integrators.

Jetway offers comprehensive system integration, hardware, software, customer-centric design services, and global logistics support. Jetway's mission is to offer you an accelerated time-to-market, reduced total-cost-of-ownership and an improved overall application with leading-edge, highly-reliable embedded technology.



"Stay modest, keep moving on."

We emphasize value, quality and service. Starting from the design stage, we focus on the value that can be integrated into products. You will always find Jetway products delivering high performance, rich features, and good cost structure. Quality cannot be more over-emphasized more in Jetway. It begins from the design phase. All the processes care consistence and Service is the number one priority in Jetway. It is a package of various supports that we offer to our partners. It includes in-time market information, product update, prompt delivery, flexible production, quick time-to-market cycle, fast RMA and warranty, local warehouse, convenient on-site service, and around the clock technical support.

HBJC400P93-2930-B

Features



- Intel® Bay Trail-M N2930 Processor
- Onboard 2GB DDR3L 1333MHz SDRAM
- 1* HDMI, 1* GbE, 1* USB3.0, 1* USB2.0
- M/B Form Factor : PICO (100x72mm)
- DC-12V_40W Adapter



Front IO

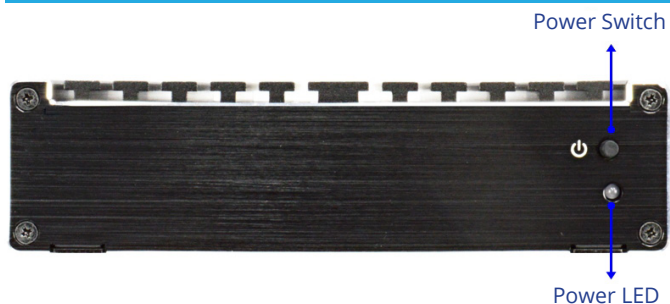

Rear IO

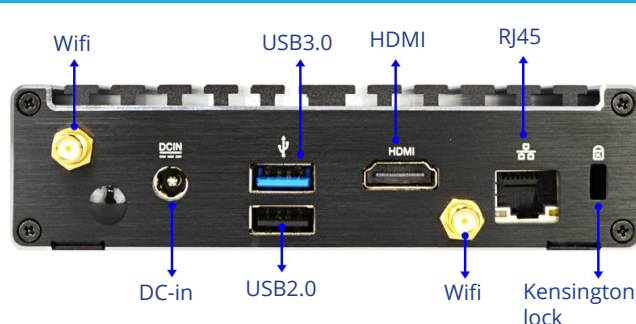

Specifications

Processor	Intel® Bay Trail-M N2930 Processor	Power	12V DC Power in DC-12V_40W Adapter
Chipset	SoC	Temperature	Operating : 0°C~50°C Storage : -10°C~70°C
Memory	Onboard 2GB DDR3L 1333MHz SDRAM	Material	Aluminum heatsink & steel plane integration structure
Ethernet	1* Realtek RTL8111G GbE	Structure	
Display Output	1* HDMI	Dimension	78.4(D) x 129(W) x 34(H)mm
Storage	1* mSATA		
Expansion Slot	1* mSATA SSD		
Front I/O	1* Power LED, 1* Power Button		
Rear I/O	1* GbE, 1* 12V DC jack, 1* HDMI, 1* USB3.0, 1* USB2.0		

*The Specification may be changed without further notice.
www.jetwayipc.com

HBJC400P691-420B

Features



- Intel® Apollo Lake N4200 SoC Processor
- 1* DDR3L 1866MHz SO-DIMM up to 8GB
- 2* USB3.0, 1* GbE, 1* HDMI, 1* Micro SIM
- Support M.2 (M-key, SATA interface, 2242) storage
- M/B Form Factor : PICO (100x72mm)
- DC-12V_40W Adapter



Front IO



Rear IO

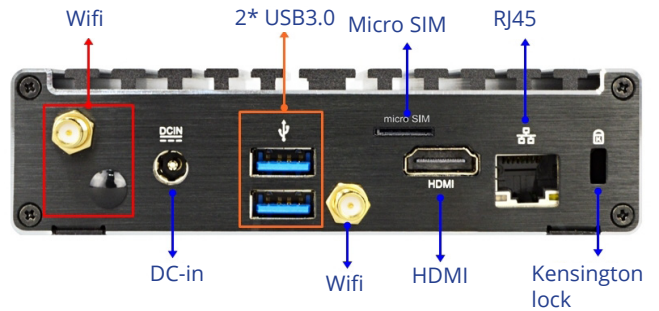

Specifications

Processor	Intel® Apollo Lake N4200Processor	Power	12V DC Power in DC-12V_40W Adapter
Chipset	SoC	Temperature	Operating : 0°C~50°C Storage : -10°C~70°C
Memory	1* DDR3L 1866MHz SO-DIMM up to 8GB	Material	Aluminum heatsink & steel plane integration structure
Ethernet	1* Realtek RTL8111H GbE	Structure	
Display Output	1* HDMI	Dimension	78.4(D) x 129(W) x 34(H)mm
Storage	1* M.2 (M-key, 2242)		
Expansion Slot	1* Full-size mini-PCIe slot (for 802.11 b/g/n + BT 4.0 installed in WIFI model)		
Front I/O	1* Power LED, 1* Power Button		
Rear I/O	2* USB, 3.0, 1* HDMI, 1* RJ45, 1* Micro SIM Card slot, 1* Kensington lock, 3* Antenna holes, 1* DC jack		

*The Specification may be changed without further notice.
www.jetwayipc.com

HBFHP792X-2807 Series

Features



- Intel® Bay Trail N2807 Processor
- Onboard 2GB DDR3L 1333MHz SDRAM
- 1* USB 3.0, 1* USB 2.0, 1* VGA, 2* RJ45, 1* DC-In jack
- DC-12V_40W Adapter
- Expansion : Different interfaces such as USB3.0/GPIO/COM/LAN expansion card can be selected



HBFHP792C-2807-G

HBFHP792G-2807-G

HBFHP792U-2807-G

HBFHP792L-2807-G

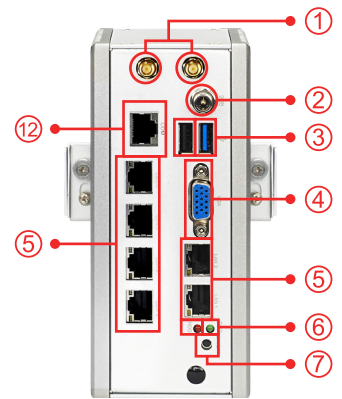
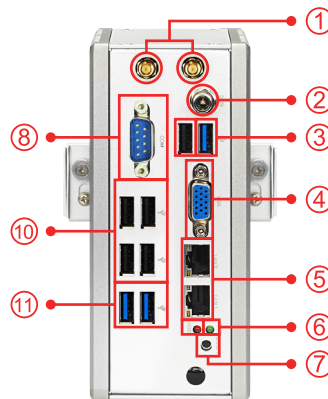
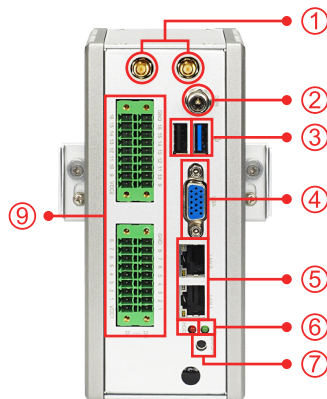
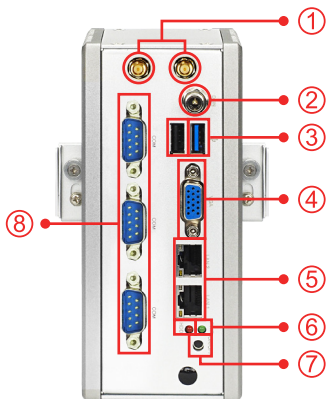

- | | | |
|----------------------|---------------------|--------------------|
| 1. WiFi | 5. LAN | 9. GPIO |
| 2. DC-in | 6. PW LED & HDD LED | 10. USB 2.0 |
| 3. USB 3.0 & USB 2.0 | 7. PW on / off | 11. USB 3.0 |
| 4. VGA | 8. COM | 12. COM(RJ45 Type) |

Specifications

Processor	Intel® Bay Trail N2807/N2930 Processor	Power	12V DC Power in DC-12V_40W Adapter
Chipset	SoC	Temperature	Operating : 0°C~50°C Storage : -10°C~70°C
Memory	2GB DDR3L 1333MHz on board memory	Material	Aluminum heatsink &
Ethernet	2* Intel GbE	Structure	steel plane integration structure
Display Output	1* VGA	Dimension	89(D) x 63(W) x 149(H) mm
Storage	1* mSATA (full size)		
Expansion Slot	1* M.2-2230 slot (for WIFI module)		
I/O	1* USB 3.0, 1* USB 2.0, 1* VGA, 6* RJ45, 1* RS232(RJ45 TYPE), 1* DC Jack , 1* Power button, 1* Power LED , 1* Reset button		
	Lan Card : 4* GbE Lan, 1* COM(RJ45 TYPE)		
	USB Card : 2* USB 3.0, 4* USB 2.0, 1* COM		
	GPIO Card : 16 bit input + 16 bit output		
	COM Card : 3* COM		

*The Specification may be changed without further notice.
www.jetwayipc.com

PICO-ITX
J10
NUC
uTX
3.5"
Mini-ITX
Desktop
Network
Expand
Proof
WT
WV
Hummer
ARM

HBFHP792B-2930-TG

Features



- Intel® Bay Trail N2930 Processor
- Onboard 2GB DDR3L 1333MHz SDRAM
- 1* USB 3.0, 1* USB 2.0, 1* VGA, 2* RJ45 (support WOL), 4* RJ45 (2 pair support ByPass)
- DC-12V_2PIN terminal block



Front IO

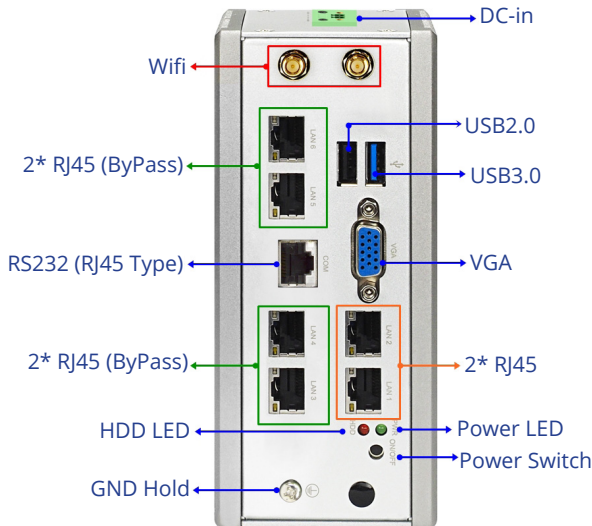

Rear IO

Specifications

Processor	Intel® Bay Taril N2930 Processor	Power	AC 90~240V to DC Adapter DC-12V_40W Adapter
Chipset	SoC	Temperature	Operating : 0°C~50°C Storage : -20°C~70°C
Memory	Onboard 2GB DDR3L 1333MHz SDRAM	Material	Aluminum heatsink & steel plane integration structure
Ethernet	2* Intel i210IT GbE	Structure	
Display Output	1* VGA	Dimension	89(D) x 63(W) x 149(H)mm
Storage	1* mSATA (full size)		
Expansion Slot	1* M.2 slot (E-key, 2230)		
Front I/O	1* Power button, 1* Power LED, 1* HDD LED, 1* USB3.0, 1* USB2.0, 1* VGA, 2* RJ45 (support WOL / GbE), 4* RJ45 (2 pair support ByPass / GbE), 1* RS232 (RJ45 type), 1* DC-in (Phoenix terminal connector)		
Rear I/O			

*The Specification may be changed without further notice.
www.jetwayipc.com

HBJC313U591-3160B

Features



- Intel® Braswell N3160 Processor
- 1* SO-DIMM DDR3L 1600MHz up to 8GB
- 1* COM, 2* HDMI, 1* DP, 2* RJ45, 4* USB 3.0
- M/B Form Factor : NUC (101x101mm)
- DC-12V_40W Adapter



Front IO

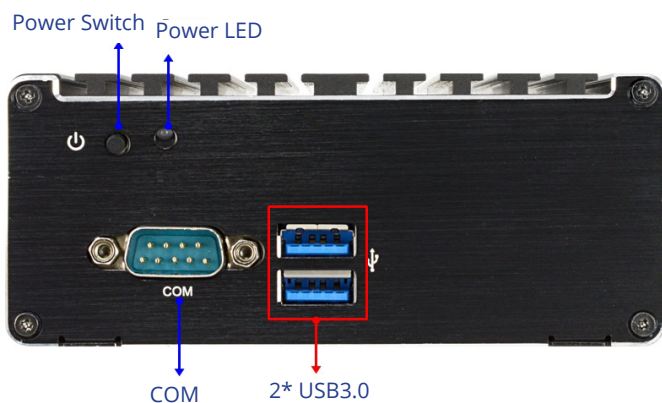

Rear IO

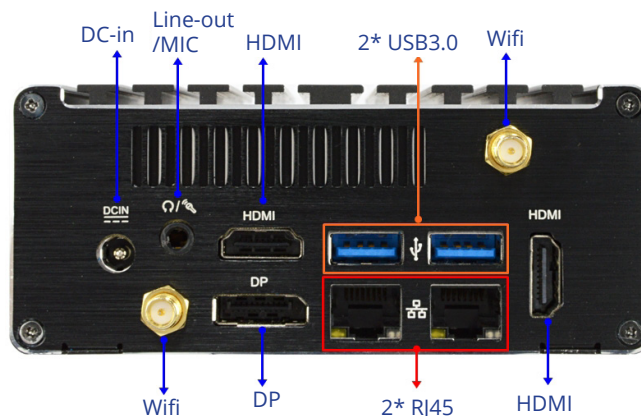

Specifications

Processor	Intel® Braswell N3160 Processor	Power	12V DC Power in DC-12V_40W Adapter
Chipset	SoC	Temperature	Operating : 0°C~50°C Storage : -10°C~70°C
Memory	1* DDR3L 1600MHz SO-DIMM up to 8GB	Material	Aluminum heatsink &
Ethernet	2* Intel i211AT GbE	Structure	steel plane integration structure
Display Output	2* HDMI, 1* DP	Dimension	110(D) x 116(W) x 49(H) mm
Storage	1* mSATA (full size)		
Expansion Slot	1* Mini PCI Express (half size), 1* SIM Card Slot		
Front I/O	2* USB 3.0, 1* COM 1* Power LED , 1* Power Button		
Rear I/O	2* USB 3.0, 2* HDMI, 1* DP, 1* Line out + MIC, 2* RJ45, 1* DC jack		

*The Specification may be changed without further notice.
www.jetwayipc.com

HBJC313U691-345B

Features



- Intel® Apollo Lake N3350/J3455 processor
- 1* SO-DIMM DDR3L 1866MHz up to 8GB
- 4* USB 3.0, 1* COM, 1* VGA, 2* HDMI, 2* RJ45, 1* Audio (Mic + Line-out)
- M/B Form Factor : NUC (101x101mm)
- DC-12V_40W Adapter



Front IO



Rear IO

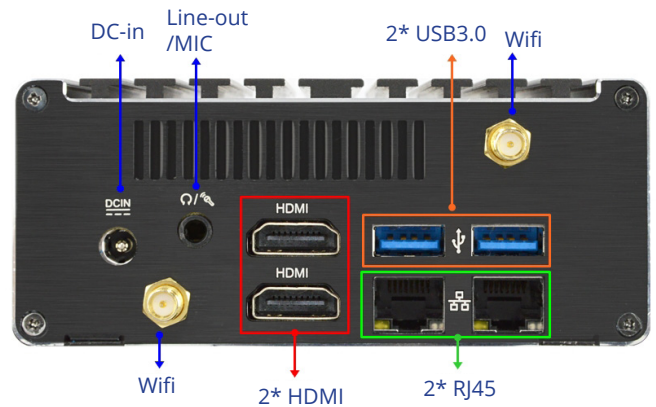

Specifications

Processor	Intel® Apollo Lake J3455 processor	Power	12V DC Power in DC-12V_40W Adapter
Chipset	SoC	Temperature	Operating : 0°C~50°C Storage : -10°C~70°C
Memory	1* DDR3L 1866MHz SO-DIMM up to 8GB	Material	Aluminum heatsink &
Ethernet	2* Realtek RTL8111H GbE	Structure	steel plane integration structure
Display Output	2* HDMI 1.4	Dimension	110(D) x 116(W) x 49(H) mm
Storage	1* mSATA (full size)		
Expansion Slot	1* Mini PCI Express (half size), 1* SIM Card Slot		
Front I/O	2* USB 3.0, 1* COM, 1* VGA 1* Power LED, 1* Power Button		
Rear I/O	2* USB 3.0, 2* HDMI, 1* Line out + MIC, 2* RJ45, 1* DC jack		

*The Specification may be changed without further notice.
www.jetwayipc.com

HBJC323U591-3160B

Features



- Intel® Braswell N3160 Processor
- 1* DDR3L 1600MHz SO-DIMM up to 8GB
- 1* COM, 2* HDMI, 1* DP, 2* RJ45, 4* USB 3.0, 1* 2.5" Device
- M/B Form Factor : NUC (101x101mm)
- DC-12V_40W Adapter



Front IO

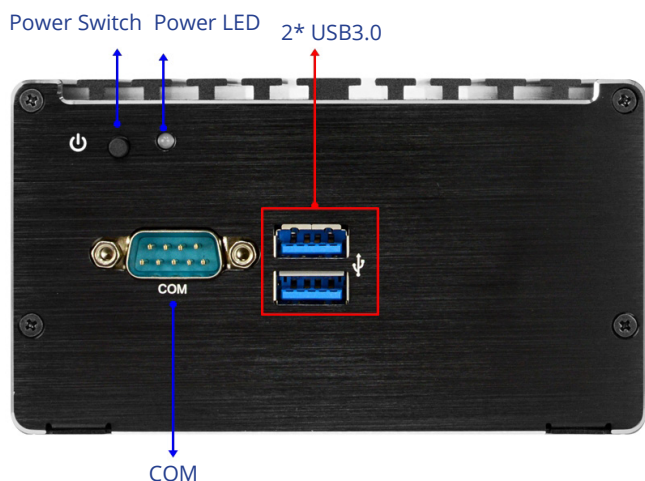

Rear IO

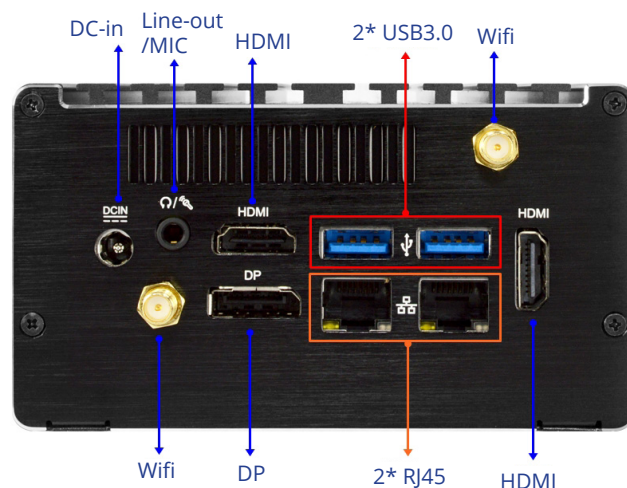

Specifications

Processor	Intel® Braswell N3160 Processor	Power	12V DC Power in DC-12V_40W Adapter
Chipset	SoC	Temperature	Operating : 0°C~50°C Storage : -10°C~70°C
Memory	1* DDR3L 1600MHz SO-DIMM up to 8GB	Material	Aluminum heatsink &
Ethernet	2* Intel i211AT GbE	Structure	steel plane integration structure
Display Output	2* HDMI, 1* DP	Dimension	110(D) x 116(W) x 65(H) mm
Storage	1* mSATA (full size), 1* 2.5" Device		
Expansion Slot	1* Mini PCI Express (half size), 1* SIM Card Slot		
Front I/O	2* USB 3.0, 1* COM 1* Power LED , 1* Power Button		
Rear I/O	2* USB 3.0, 2* HDMI, 1* DP, 1* Line out + MIC, 2* RJ45, 1* DC Jack		

*The Specification may be changed without further notice.
www.jetwayipc.com

HBJC323U691-345B

Features



- Intel® Apollo Lake N3350/J3455 processor
- 1* DDR3L 1866MHz SO-DIMM up to 8GB
- 4* USB 3.0, 1* COM, 1* VGA, 2* HDMI, 2* RJ45, 1* Audio (Mic + Line-out)
- M/B Form Factor : NUC (101x101mm)
- DC-12V_40W Adapter



Front IO

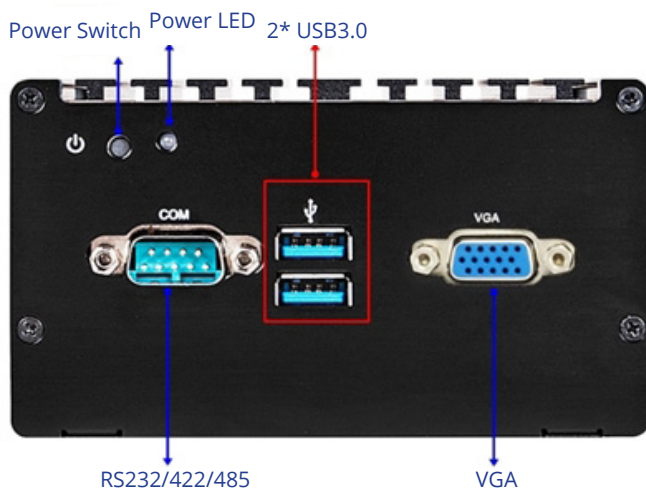

Rear IO

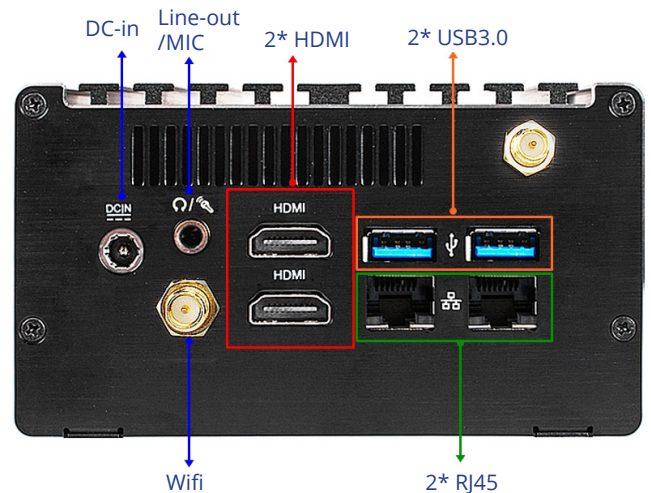

Specifications

Processor	Intel® Apollo Lake N3350/J3455 processor	Power	12V DC Power in DC-12V_40W Adapter
Chipset	SoC	Temperature	Operating : 0°C~50°C Storage : -10°C~70°C
Memory	1* DDR3L 1866MHz SO-DIMM up to 8GB	Material	Aluminum heatsink &
Ethernet	2* Realtek RTL8111H GbE	Structure	steel plane integration structure
Display Output	2* HDMI 1.4	Dimension	110(D) x 116(W) x 65(H) mm
Storage	1* mSATA (full size), 1* 2.5" Device		
Expansion Slot	1* Mini PCI Express (half size), 1* SIM Card Slot		
Front I/O	2* USB 3.0 , 1* COM , 1* VGA 1* Power LED , 1* Power Button		
Rear I/O	2* USB 3.0, 2* HDMI, 1* Line out + MIC, 2* RJ45, 1* DC Jack		

*The Specification may be changed without further notice.
www.jetwayipc.com

HBJC420U591-3160B

Features



- Intel® Braswell N3160 Processor
- 1* DDR3L 1600MHz SO-DIMM up to 8GB
- 1* COM, 2* HDMI, 1* DP, 2* RJ45, 4* USB 3.0
- M/B Form Factor : NUC (101x101mm)
- DC-12V_40W Adapter



Front IO

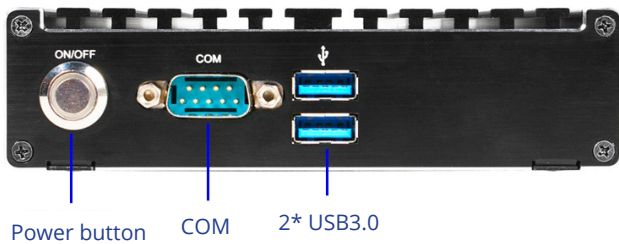

Rear IO

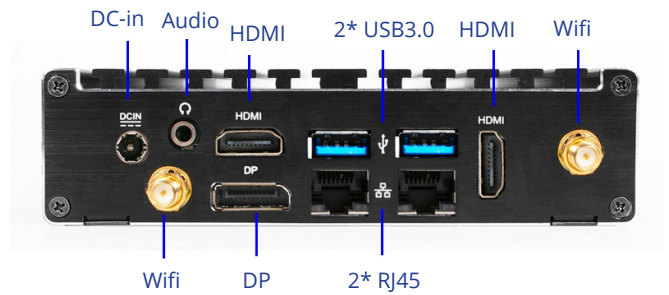

Specifications

Processor	Intel® Braswell N3160 Processor	Power	12V DC Power in DC-12V_40W Adapter
Chipset	SoC	Temperature	Operating : 0°C~50°C Storage : -10°C~70°C
Memory	1* DDR3L 1600MHz SO-DIMM up to 8GB	Material	Aluminum heatsink &
Ethernet	2* Intel i211AT GbE	Structure	steel plane integration structure
Display Output	2* HDMI, 1* DP	Dimension	109.4(D) x 129(W) x 34(H) mm
Storage	1* mSATA (full size)		
Expansion Slot	1* Mini PCI Express (half size), 1* SIM Card Slot		
Front I/O	2* USB 3.0, 1* COM 1* Power LED , 1* Power Button		
Rear I/O	2* USB 3.0, 2* HDMI, 1* DP, 1* Line out + MIC, 2* RJ45, 1* DC Jack		

*The Specification may be changed without further notice.
www.jetwayipc.com

PICO-ITX
J10
NUC
uTX
3.5"
Mini-ITX
Desktop
Network
Expand
Proof
WT
WV
Hummer
ARM

HBJC420U691-345B

Features



- Intel® Apollo Lake J3455 SoC Processor
- 1* DDR3L 1866MHz SO-DIMM up to 8 GB
- 4* USB 3.0, 1* Line-Out/ MIC, 2* HDMI, 1* VGA, 2* RJ45, 1* COM
- DC-12V_40W Adapter



Front IO

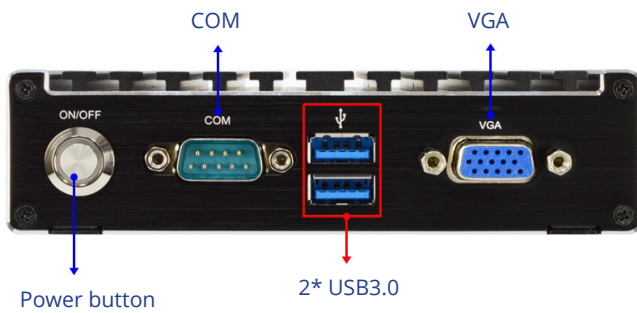

Rear IO

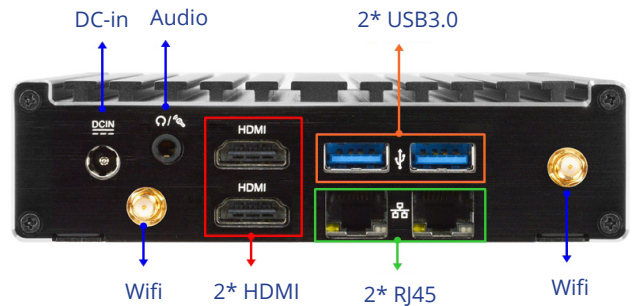

Specifications

Processor	Intel® Apollo Lake J3455 SoC Processor	Power	12V DC Power in DC-12V_40W Adapter
Chipset	SoC	Temperature	Operating : 0°C~50°C Storage : -10°C~70°C
Memory	1* DDR3L 1866MHz SO-DIMM up to 8GB	Material	Aluminum heatsink &
Ethernet	2* Realtek RTL8111H GbE	Structure	steel plane integration structure
Display Output	2* HDMI, 1* VGA	Dimension	109.4(D) x 129(W) x 34(H) mm
Storage	1* mSATA (full size)		
Expansion Slot	1* Mini PCI Express (half size), 1* SIM Card Slot		
Front I/O	2* USB 3.0, 1* VGA, 1* COM 1* Power LED, 1* Power Button		
Rear I/O	2* USB 3.0, 2* HDMI, 2* RJ45, 1* Line-out+Mic-in, 1* DC Jack		

*The Specification may be changed without further notice.
www.jetwayipc.com

HBJC430U941-316B

Features



- Intel® Braswell N3160 Processor
- 1* DDR3L 1600MHz SO-DIMM up to 8GB
- 1* COM(RJ45 TYPE), 1* HDMI, 4* RJ45, 2* USB 3.0
- M/B Form Factor : NUC (101x101mm)
- DC-12V_40W Adapter



Front IO

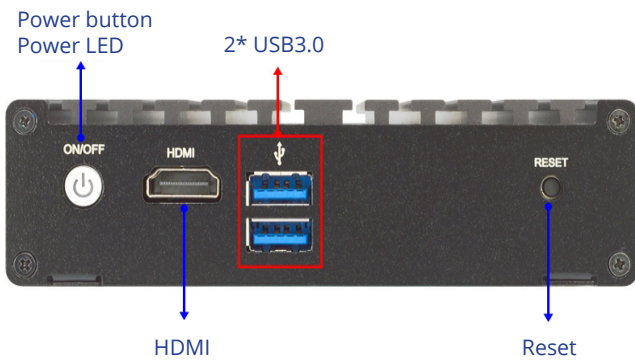

Rear IO

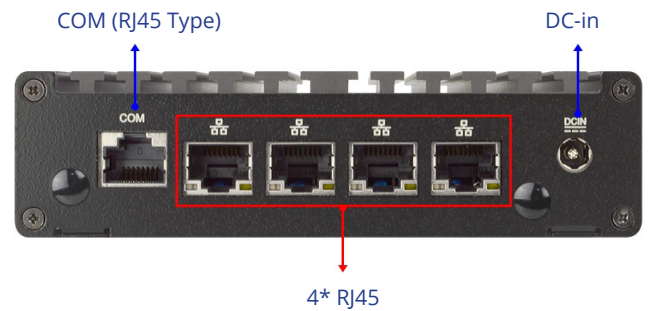

Specifications

Processor	Intel® Braswell N3160 Processor	Power	12V DC Power in DC-12V_40W Adapter
Chipset	SoC	Temperature	Operating : 0°C~50°C Storage : -10°C~70°C
Memory	1* DDR3L 1600MHz SO-DIMM up to 8GB	Material	Aluminum heatsink &
Ethernet	4* Intel i211AT GbE	Structure	steel plane integration structure
Display Output	1* HDMI	Dimension	109.4(D) x 129(W) x 34(H) mm
Storage	1* M.2 (M-key, 2242)		
Expansion Slot	1* Mini PCI Express (Full size), 1* SIM Card Slot		
Front I/O	1* HDMI, 2* USB 3.0 1* Power LED, 1* Power Button, 1* RESET		
Rear I/O	1* COM(RJ45 TYPE), 4* RJ45, 1* DC Jack		

*The Specification may be changed without further notice.
www.jetwayipc.com

PICO-ITX
J10
NUC
uTX
3.5"
Mini-ITX
Desktop
Network
Expand
Proof
WT
WV
Hummer
ARM

HBFBU691-3455-B

Features



- Intel® Apollo Lake J3455 SoC Processor
- 1* DDR3L 1866MHz SO-DIMM up to 8GB
- 4* USB3.0, 1* RS232/422/485, 2* GbE, 1*Audio
- 1* VGA, 2* HDMI
- DC-12V_40W Adapter



Front IO

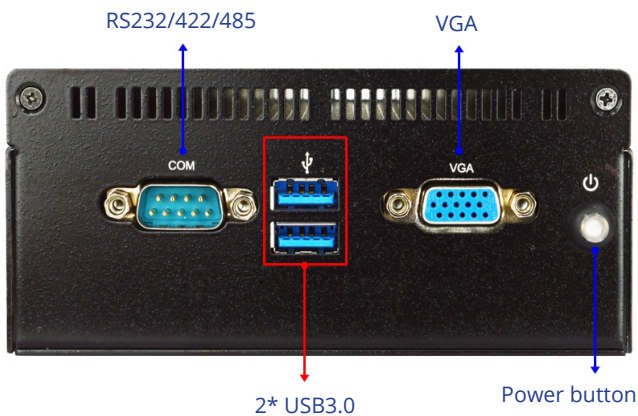

Rear IO

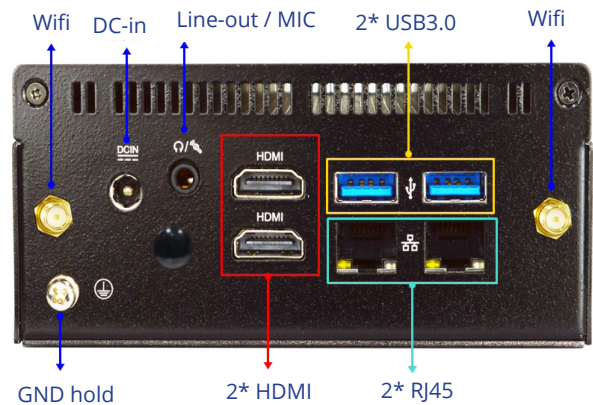

Specifications

Processor	Intel® Apollo Lake J3455 SoC Processor	Power	12V DC Power in DC-12V_40W Adapter
Chipset	SoC	Temperature	Operating : 0°C~50°C Storage : -10°C~70°C
Memory	1* DDR3L 1866MHz SO-DIMM up to 8GB	Material	Aluminum heatsink &
Ethernet	2* Realtek RTL8111H GbE	Structure	steel plane integration structure
Display Output	1* VGA, 2* HDMI	Dimension	109.2(D) x 125(W) x 55.5(H) mm
Storage	1* mSATA (full size)		
Expansion Slot	1* half size Mini PCIe		
Front I/O	1* VGA, 2* USB 3.0, 1* RS232/422/485, 1* power button		
Rear I/O	2* USB3.0, 2* HDMI, 2* GbE, 1* GND hold, 1* Line-out/MIC combo, 1* DC-in jack		

*The Specification may be changed without further notice.
www.jetwayipc.com

HBFBU02-00-B

Features



- Intel® Apollo Lake J3455 SoC Processor
- 1* DDR3L SO-DIMM up to 8GB
- 1* DP, 2* HDMI
- 3* USB3.0, 1* USB type-C, 2* GbE, 1*Audio, 1* RS232/422/485
- M/B Form Factor : NUC (101x101mm)
- DC-12V_40W Adapter



Front IO

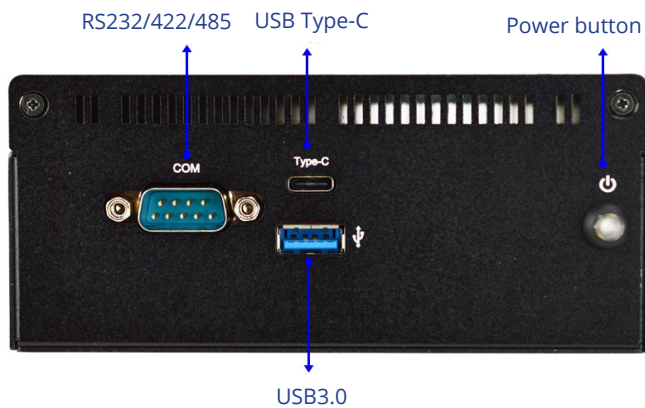

Rear IO

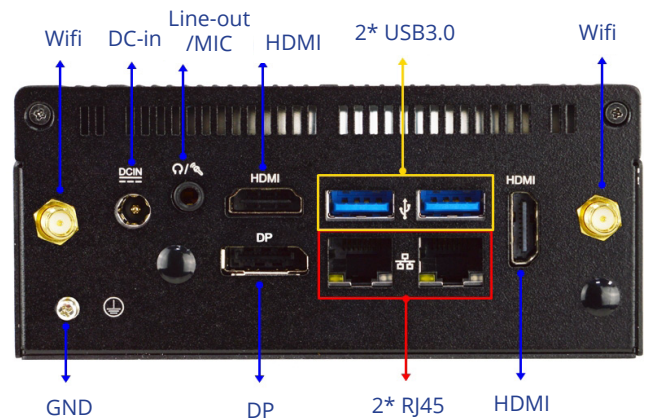

Specifications

Processor	Intel® Apollo Lake J3455 SoC Processor	Power	AC 90~240V input DC-12V Adapter
Chipset	SoC	Temperature	Operating : 0°C~50°C Storage : -10°C~70°C
Memory	1* DDR3L 1866MHz SO-DIMM up to 8GB	Material	Aluminum heatsink &
Ethernet	1* Realtek RTL8111K GbE, 1* RTL8125BS 2.5GbE	Structure	steel plane integration structure
Display Output	1* HDMI, 1* DP	Dimension	109.2(D) x 125(W) x 55.5(H) mm
Storage	1* M.2 (M-key 2242, SATA interface), 32GB eMMC		
Expansion Slot	1* M.2 (E-key 2230, PCIe1 interface)		
Front I/O	1 * USB 3.0, 1* USB type-C, 1* COM (RS232/422/485), 1* power button		
Rear I/O	2* USB 3.0, 2* HDMI, 1* DP, 2* GbE, 1* GND hold, 1* Line-out/MIC combo, 1* DC-in jac		

*The Specification may be changed without further notice.
www.jetwayipc.com

PICO-ITX
J10
NUC
iTX
3.5"
Mini-ITX
Desktop
Network
Expand
Proof
WT
WV
Hummer
ARM

HBFCU792C-7100-B

Features



- Intel® Skylake/Kabylake U-series SoC Processor
- 2* DDR4 2133MHz SO-DIMM up to 32 GB
- 1* HDMI, 1* DP, 2* RJ45, 2* USB2.0, 6 * USB3.0, 1* RS232/422/485, 1* SIM Card Slot
- M/B Form Factor : NUC (101x101mm)
- DC-12V_60W Adapter



Front IO

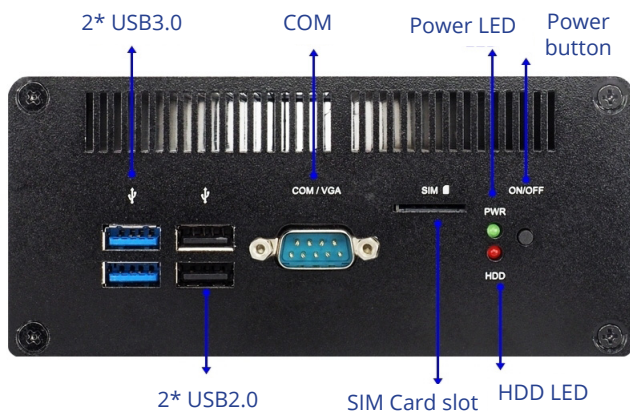

Rear IO

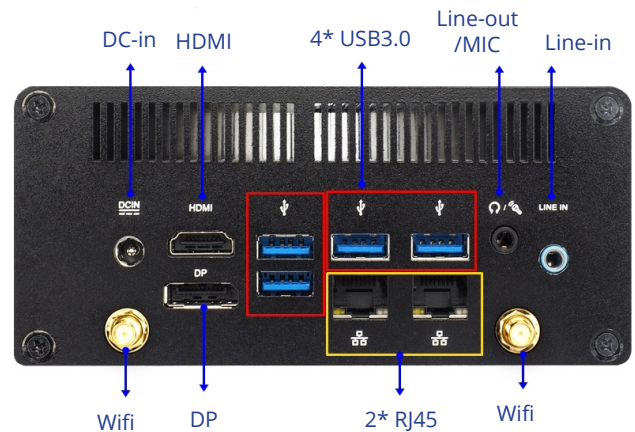

Specifications

Processor	Intel® Skylake/Kabylake U-series Processor	Power	AC 90~240V input DC-12V_60W Adapter
Chipset	SoC	Temperature	Operating : 0°C~50°C Storage : -20°C~70°C
Memory	2* DDR4 2133MHz SO-DIMM up to 32GB	Material	Aluminum heatsink &
Ethernet	1* Intel i211AT GbE, 1* Intel i219LM GbE	Structure	steel plane integration structure
Display Output	1* HDMI, 1* DP	Dimension	116.9(D) x 144(W) x 65(H) mm
Storage	1* SATAIII (only support 2.5" HDD height≤10mm) 1* full-size mSATA/Mini-PCIe shared slot		
Expansion Slot	1* half size Mini PCIe		
Front I/O	2* USB2.0, 2 * USB3.0, 1* RS232/422/485, 1* Power button, 1* Power LED, 1* HDD LED, 1* SIM Card Slot		
Rear I/O	4 * USB3.0, 1* HDMI, 1* DP, 2* RJ45, 1* Line-in, 1* MIC/Line-out Combo, 1* DC-in jack		

*The Specification may be changed without further notice.
www.jetwayipc.com

HBFCU792V-3965-B

Features



- Intel® Skylake/Kabylake U-series SoC Processor
- 2* DDR4 2133MHz SO-DIMM up to 32 GB
- 1* HDMI, 1* DP, 2* RJ45, 4* USB2.0, 4 * USB3.0, 1* VGA, 1* SIM Card Slot
- M/B Form Factor : NUC (101x101mm)
- DC-12V_60W Adapter



Front IO

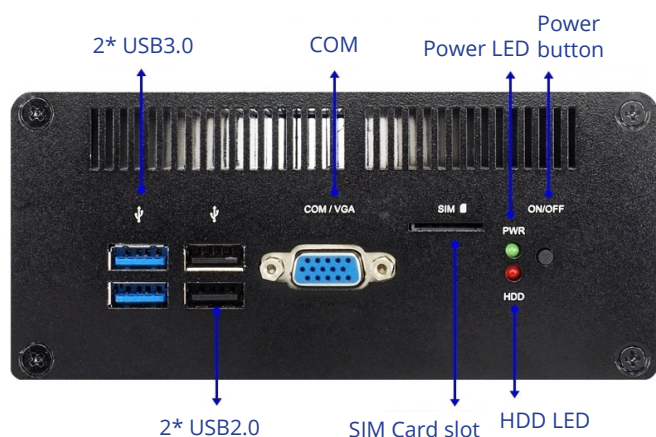

Rear IO

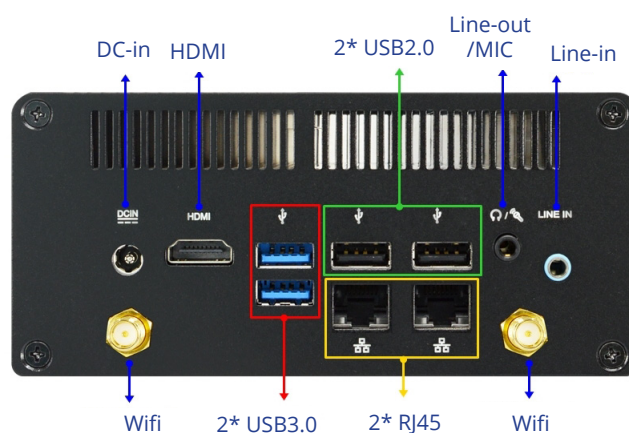

Specifications

Processor	Intel® Skylake/Kabylake U-series Processor	Power	AC 90~240V input DC-12V_60W Adapter
Chipset	SoC	Temperature	Operating : 0°C~50°C Storage : -20°C~70°C
Memory	2* DDR4 2133MHz SO-DIMM up to 32GB	Material	Aluminum heatsink &
Ethernet	1* Intel i211AT GbE, 1* Intel i219LM GbE	Structure	steel plane integration structure
Display Output	1* HDMI, 1* VGA	Dimension	116.9(D) x 144(W) x 65(H) mm
Storage	1* SATAIII (only support 2.5" HDD height≤10mm) 1* full-size mSATA/Mini-PCIe shared slot		
Expansion Slot	1* half size Mini PCIe		
Front I/O	2* USB2.0, 2 * USB3.0, 1* VGA, 1* Power button, 1* Power LED, 1* HDD LED, 1* SIM Card Slot		
Rear I/O	2* USB3.0, 2* USB2.0, 1* HDMI, 2* RJ45, 1* Line-in, 1* MIC/Line-out Combo, 1* DC-in jack		

*The Specification may be changed without further notice.
www.jetwayipc.com

HBJC365F3A-2930-B

Features



- Intel BayTrail-M N2930 Processor
- 1* DDR3L 1333MHz SO-DIMM up to 8GB
- 1* DVI-I, 2* RJ45, 2* USB3.0, 2* USB2.0
- M/B Form Factor : 3.5"(148x102mm)
- DC-12V_60W Adapter



Front IO

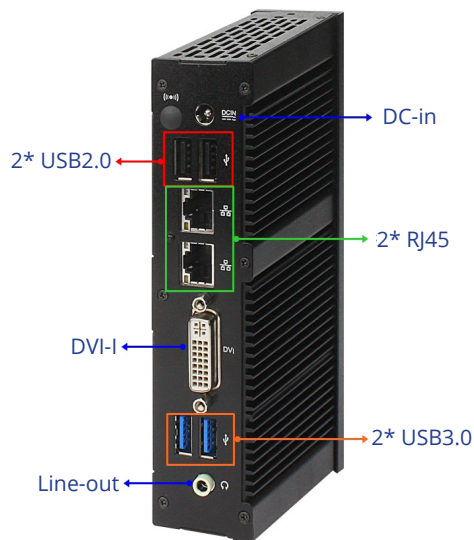

Rear IO

Specifications

Processor	Intel® BayTrail-M N2930 Processor	Power	9~24V DC Power in DC-12V_60W Adapter
Chipset	SoC	Temperature	Operating : 0°C~50°C Storage : -10°C~70°C
Memory	1* SO-DIMM DDR3L 1333MHz up to 8GB	Material	Aluminum heatsink &
Ethernet	2* Realtek RTL8111G GbE	Structure	steel plane integration structure
Display Output	1* DVI-I	Dimension	111(D) x 153(W) x 35(H) mm
Storage	1* mSATA (full size shared), 1* 2.5" Device		
Expansion Slot	2* Mini PCI Express (full & half size)		
Front I/O	1* Power LED, 1* HDD LED, 1* Power Button		
Rear I/O	2* USB3.0, 2* USB2.0, 1* DVI-I, 2* RJ45, 1* Line-out, 1* DC Jack		

*The Specification may be changed without further notice.
www.jetwayipc.com

HBJC366F831-293B

Features



- Intel® BayTrail-M N2930 Processor
- 1* DDR3L 1333MHz SO-DIMM up to 8GB
- 1* HDMI, 1*VGA, 1* RJ45,
1* USB 3.0, 3* USB 2.0
- M/B Form Factor : 3.5" (148x102mm)
- DC-12V_40W Adapter



Front IO



Rear IO

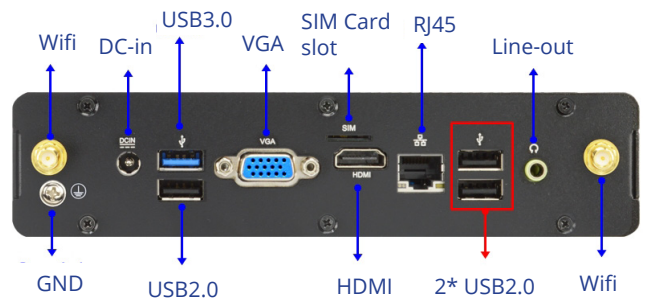

Specifications

Processor	Intel® BayTrail-M N2930 Processor	Power	12V DC Power in DC-12V_40W Adapter
Chipset	SoC	Temperature	Operating : 0°C~50°C Storage : -10°C~70°C
Memory	1* DDR3L 1333MHz SO-DIMM up to 8GB	Material	Aluminum heatsink &
Ethernet	1* Realtek RTL8111G GbE	Structure	steel plane integration structure
Display Output	1* HDMI, 1* VGA	Dimension	106(D) x 184(W) x 42(H) mm
Storage	1* M.2 SATA Device (M-key 2242/2280), 1* 2.5" Device		
Expansion Slot	1* Mini PCI Express (full size)		
Front I/O	1* Power LED, 1* Power Button		
Rear I/O	1* USB 3.0, 3* USB 2.0, 1* HDMI, 1* VGA, 1* RJ45, 1* Line out, 1* SIM Card slot, 1* DC Jack		

*The Specification may be changed without further notice.
www.jetwayipc.com

HBJC366F832-345B

Features



- Intel® Apollo Lake SoC Processor
- 1* DDR3L 1866MHz SO-DIMM up to 8GB
- 2* HDMI, 4* USB3.0, 1* GbE, 1* SIM Card slot, 1* Line out
- 1* Full size Mini PCIe, 1* M.2 (M-key, 2242/2280), 1* M.2 (E-key, 2230)
- M/B Form Factor : 3.5" (148x102mm)
- DC-12V_60W Adapter

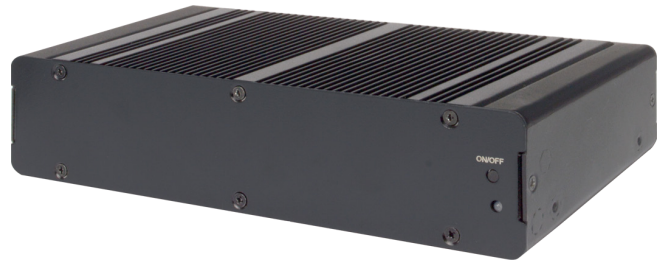

Front IO



Rear IO

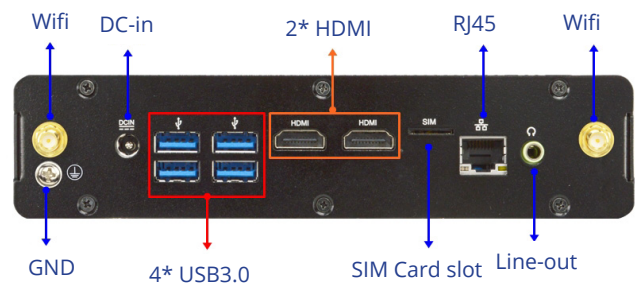

Specifications

Processor	Intel® Apollo Lake J3455 Processor	Power	12V DC Power in DC-12V_40W Adapter
Chipset	SoC	Temperature	Operating : 0°C~50°C Storage : -10°C~70°C
Memory	1* DDR3L 1866MHz SO-DIMM up to 8GB	Material	Aluminum heatsink &
Ethernet	1* Realtek RTL8111G GbE	Structure	steel plane integration structure
Display Output	2* HDMI	Dimension	106(D) x 184(W) x 42(H) mm
Storage	1* M.2 SATA Device (M-key 2242/2280), 1* 2.5" Device		
Expansion Slot	1* Mini PCI Express (full size), 1* M.2 (E-key 2230) PCIe slot		
Front I/O	1* Power LED, 1* Power Button		
Rear I/O	4* USB 3.0, 2* HDMI, 1* RJ45, 1* Line out, 1* SIM Card slot, 1* DC Jack		

*The Specification may be changed without further notice.
www.jetwayipc.com

HBJC375F3A-2930-B

Features



- Intel BayTrail-M N2930 Processor
- 1* SO-DIMM DDR3L 1333MHz up to 8GB
- 1* DVI-I, 2* RJ45, 1* USB 3.0, 5* USB 2.0, 4* COM (Max.)
- M/B Form Factor : 3.5" (148x102mm)
- DC-12V_60W Adapter



Front IO

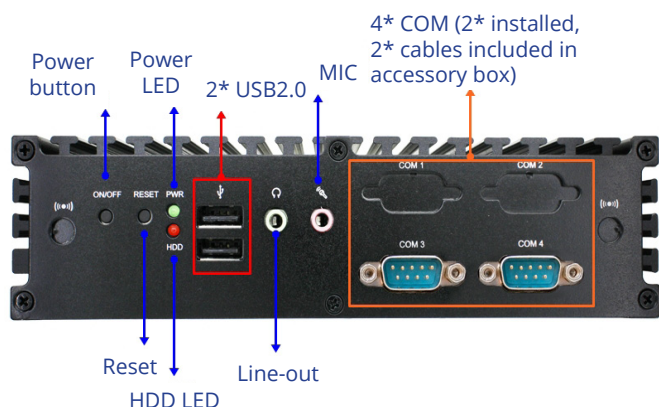

Rear IO

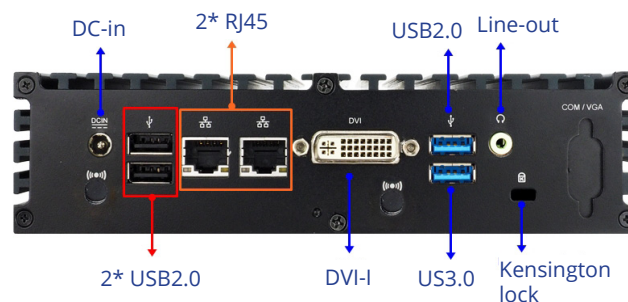

Specifications

Processor	Intel® BayTrail-M N2930 Processor	Power	9~24V DC Power in DC-12V_60W Adapter
Chipset	SoC	Temperature	Operating : 0°C~50°C Storage : -10°C~70°C
Memory	1* DDR3L 1333MHz SO-DIMM up to 8GB	Material	Aluminum heatsink &
Ethernet	2* Realtek RTL8111G GbE	Structure	steel plane integration structure
Display Output	1* DVI-I	Dimension	142(D) x 185(W) x 48(H) mm
Storage	1* mSATA (full size shared), 1* 2.5" Device		
Expansion Slot	2* Mini PCI Express (full & half size)		
Front I/O	1* Power LED, 1* HDD LED, 1* Power Button, 1* Reset button, 2* USB 2.0, 4* COM (Max.), 1* MIC, 1* Line out		
Rear I/O	1* USB 3.0, 3* USB 2.0, 1* DVI-I, 2* RJ45, 1* Line out, 1* DC Jack		

*The Specification may be changed without further notice.
www.jetwayipc.com

HBJC375F532-2930-B

Features



- Intel BayTrail-M N2930 Processor
- 1* SO-DIMM DDR3L 1333MHz up to 8GB
- 1* VGA, 1* DVI-I, 2* RJ45, 1* USB 3.0, 5* USB 2.0, 4* COM (Max.)
- M/B Form Factor : 3.5" (148x102mm)
- DC-12V_60W Adapter



Front IO

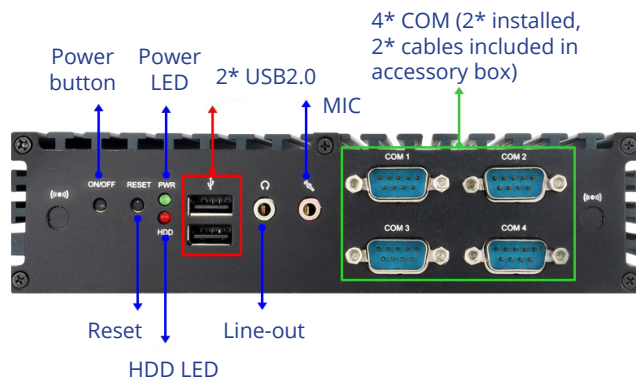

Rear IO

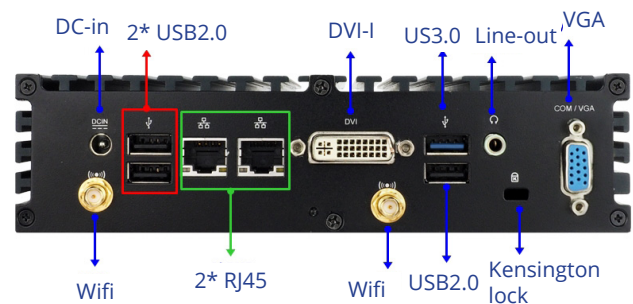

Specifications

Processor	Intel® BayTrail-M N2930 Processor	Power	9~24V DC Power in DC-12V_60W Adapter
Chipset	SoC	Temperature	Operating : 0°C~50°C Storage : -10°C~70°C
Memory	1* DDR3L 1333MHz SO-DIMM up to 8GB	Material	Aluminum heatsink &
Ethernet	2* Realtek RTL8111G GbE	Structure	steel plane integration structure
Display Output	1* DVI-I	Dimension	142(D) x 185(W) x 48(H) mm
Storage	1* mSATA (full size shared), 1* 2.5" Device		
Expansion Slot	2* Mini PCI Express (full & half size)		
Front I/O	1* Power LED, 1* HDD LED, 1* Power Button, 1* Reset button, 2* USB 2.0, 4* COM (Max.), 1* MIC, 1* Line out		
Rear I/O	1* USB 3.0, 3* USB 2.0, 1* VGA, 1* DVI-I, 2* RJ45, 1* Line out, 1* DC Jack		

*The Specification may be changed without further notice.
www.jetwayipc.com

HBJC376C55-2930-B

Features



- Intel® BayTrail-M N2930 Processor
- On board 2GB DDR3L 1333MHz
- 1* VGA, 1* HDMI, 2* RJ45, 1* USB 3.0, 5* USB 2.0, 6* COM, 1* 3W Speaker, 1* GPIO
- Form Factor : 185 x 142 x 48mm
- DC-12V_60W Adapter



Front IO

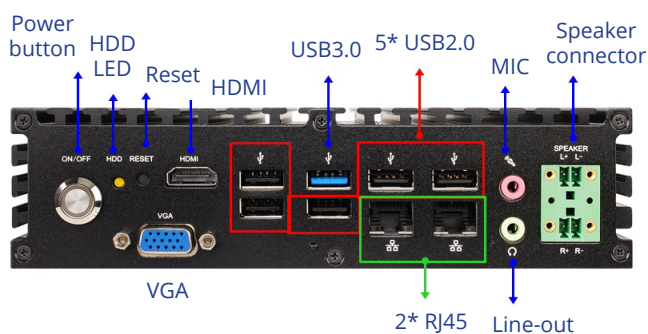

Rear IO

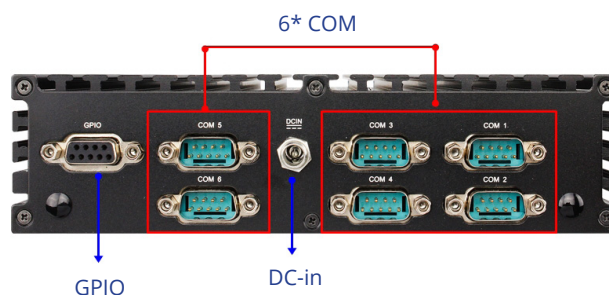

Specifications

Processor	Intel® BayTrail-M N2930 Processor	Power	9~24V DC Power in DC-12V_60W Adapter
Chipset	SoC	Temperature	Operating : 0°C~50°C Storage : -10°C~70°C
Memory	Onboard 2GB DDR3L 1333MHz	Material	Aluminum heatsink & steel plane
Ethernet	2* Intel i211AT GbE	Structure	integration structure
Display Output	1* VGA, 1* HDMI	Dimension	142(D) x 185(W) x 48(H) mm
Storage	1* mSATA (full size), 1* 2.5" Device		
Expansion Slot	2* Mini PCI Express (full & half size)		
Front I/O	1* Power LED, 1* HDD LED, 1* Power Button, 1* Reset button, 1* USB 3.0, 5* USB 2.0, 2* RJ45, 1* MIC, 1* Line out, 1* 3W Speaker, 1* HDMI, 1* VGA		
Rear I/O	6* COM (4* RS232, 2* RS232/422/485), 1* GPIO, 1* DC Jack		

*The Specification may be changed without further notice.
www.jetwayipc.com

HBJC377F631-3455B

Features



- Intel® Apollo Lake J3455 processor
- 1* DDR3L 1600MHz SO-DIMM up to 8GB
- 2* USB 2.0, 4* USB 3.0, 2* DP, 2* RJ45, 1* RS232(RJ45 TYPE), 1* Micro SD card slot, 1* Audio
- M/B Form Factor : 3.5" (148x102mm)
- DC-12V_60W Adapter



Front IO

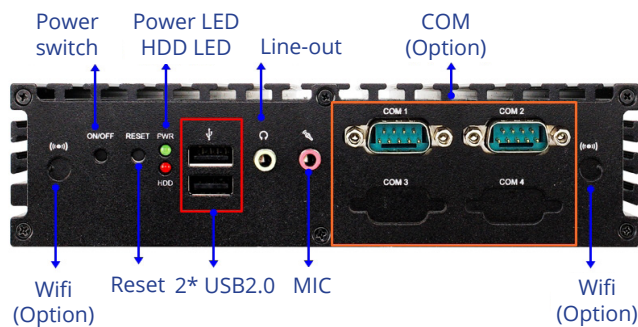

Rear IO

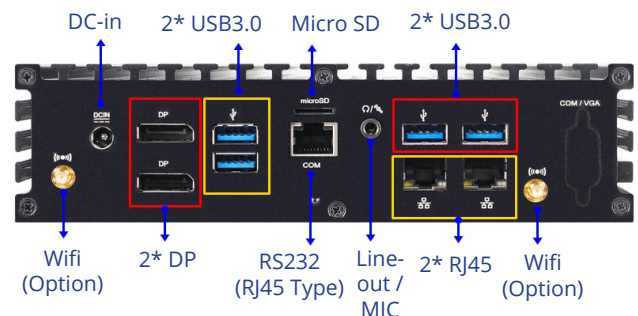

Specifications

Processor	Intel® Apollo Lake J3455 Processor	Power	9~36V DC Power in DC-12V_60W Adapter
Chipset	SoC	Temperature	Operating : 0°C~50°C Storage : -10°C~70°C
Memory	1* DDR3L 1600MHz SO-DIMM up to 8GB	Material	Aluminum heatsink & steel plane integration structure
Ethernet	2* Intel® GbE	Structure	
Display Output	2* DP	Dimension	142(D) x 185(W) x 48(H) mm
Storage	1* M.2 (M key-2242), 1* 2.5" Device		
Expansion Slot	1* Mini PCI Express (full size)		
Front I/O	1* Power LED, 1* HDD LED, 1* Power Button, 1* Reset button, 2* USB 2.0, 4* COM (Max.), 1* MIC, 1* Line out		
Rear I/O	4* USB 3.0, 2* RJ45, 1* COM (RJ-45 Type), 2* DP, 1* Micro SD card slot, 1* DC jack		

*The Specification may be changed without further notice.
www.jetwayipc.com

HBJC377F831-2930-B

Features



- Intel® Bay Trail N2930 SoC Processor
- 1* DDR3L 1333MHz SO-DIMM up to 8GB
- 1* HDMI, 1* VGA, 1* RJ45, 1* USB 3.0, 5* USB 2.0
- 1x M.2 (2242/2280) , 1x M.2 (2230)
- M/B Form Factor : 3.5" (148x102mm)
- DC-12V_60W Adapter



Front IO

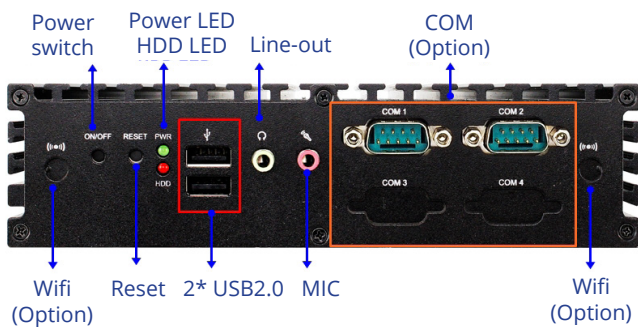

Rear IO

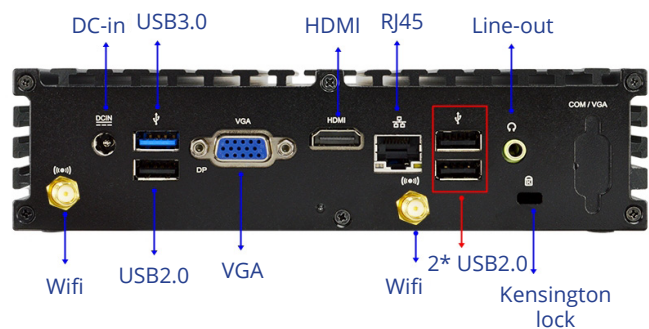

Specifications

Processor	Intel® Bay Trail N2930 SoC Processor	Power	12V DC Power in DC-12V_60W Adapter
Chipset	SoC	Temperature	Operating : 0°C~50°C Storage : -10°C~70°C
Memory	1* DDDR3L 1333MHz SO-DIMM up to 8GB	Material	Aluminum heatsink &
Ethernet	1* Realtek RTL8111H GbE	Structure	steel plane integration structure
Display Output	1* HDMI, 1* VGA	Dimension	142(D) x 185(W) x 48(H) mm
Storage	1* M.2 (2242/2280), 1* M.2 (2230), 1* 2.5" Device		
Expansion Slot	1* Mini PCIe (Full size)		
Front I/O	1* Power LED, 1* HDD LED, 1* Power Button, 1* Reset button, 2* USB2.0, 1* Audio		
Rear I/O	3* USB2.0, 1* USB3.0, 1* Audio, 1* RJ45, 1* VGA, 1* HDMI, 1*DC jack		

*The Specification may be changed without further notice.
www.jetwayipc.com

HBJC382F3E-4300UB

Features



- Intel® Haswell-U 4300U SoC processor
- 2* DDR3L 1600MHz SO-DIMM up to 16GB
- 2* HDMI, 2* RJ45, 4* USB3.0, 4* USB2.0, 4* COM (Max.)
- M/B Form Factor : 3.5" (148x102mm)
- DC-12V_60W Adapter



Front IO

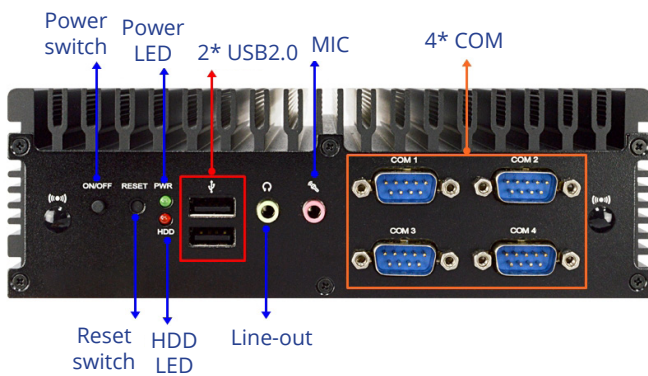

Rear IO

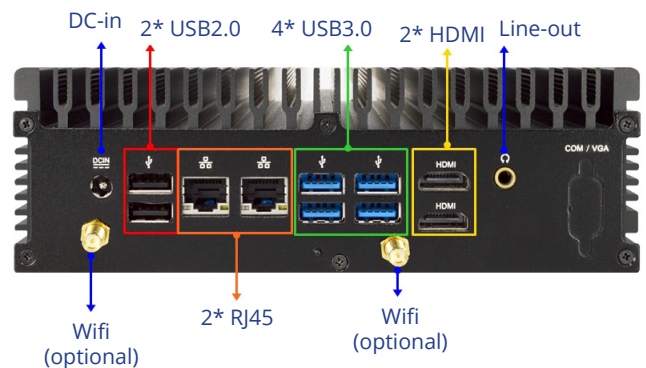

Specifications

Processor	Intel® Haswell-U 4300U SoC Processor	Power	12V DC Power in DC-12V_60W Adapter
Chipset	SoC	Temperature	Operating : 0°C~50°C Storage : -10°C~70°C
Memory	2* DDR3L 1600MHz SO-DIMM up to 16GB	Material	Aluminum heatsink &
Ethernet	1* Intel I211AT GbE, 1* Intel I218LM	Structure	steel plane integration structure
Display Output	2* HDMI	Dimension	142(D) x 185(W) x 60(H) mm
Storage	1* mSATA, 1* 2.5" Device		
Expansion Slot	1* Mini PCI Express (half size)		
Front I/O	1* Power LED, 1* HDD LED, 1* Power Button, 1* Reset Button, 2* USB2.0, 4* COM (Max.), 1* MIC, 1* Line out		
Rear I/O	4* USB3.0, 2* USB2.0, 2* RJ45, 2* HDMI, 1* Line out, 1* DC jack		

*The Specification may be changed without further notice.
www.jetwayipc.com

HBJC511F595-110-B

Features



- Intel® LGA 1151 Core i3/i5/i7 Processors (35W)
- 2* DDR4 2133MHz SO-DIMM up to 32G
- 4* USB2.0, 4* USB3.0, 2* COM, 1* DP, 1* HDMI, 1* RJ45, 1* Mic, 1 * Line out
- M/B Form Factor : Mini ITX (170x170mm)
- DC-19V_120W Adapter



Front IO



Rear IO

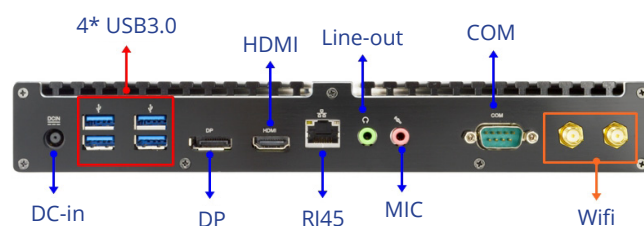

Specifications

Processor	Intel® LGA 1151 Core i3/i5/i7 Processors (35W)	Power	19V DC Power in DC-19V_120W Adapter
Chipset	Intel H110 chipset	Temperature	Operating : 0°C~40°C Storage : -10°C~70°C
Memory	2* DDR4 2133MHz SO-DIMM up to 32GB	Material	Aluminum heatsink &
Ethernet	1* Intel i219V GbE	Structure	steel plane integration structure
Display Output	1* HDMI, 1* DP	Dimension	199.4(D) x 264(W) x 38(H) mm
Storage	1* mSATA (full size), 1* 2.5" Device		
Expansion Slot	1* Mini PCI Express (half size)		
Front I/O	1* Power LED, 1* HDD LED, 1* Power button, 1* Reset button, 2* USB 2.0, 1* Line out, 1* MIC		
Rear I/O	4* USB 3.0, 1* RJ45, 1* HDMI, 1* DP, 1* COM, 1* MIC , 1* Line out, 1* DC Jack		

*The Specification may be changed without further notice.
www.jetwayipc.com

HBJC902LBT-1900

Features



- Intel® Bay Trail-D J1900 SoC processor
- 1* DDR3L SO-DIMM up to 8GB
- 1* USB3.0, 5* USB2.0, 4* COM, 1* RJ45
- 1* VGA, 1* HDMI
- M/B Form Factor : Mini ITX (170x170mm)
- DC-12V Adapter



Front IO

Rear IO

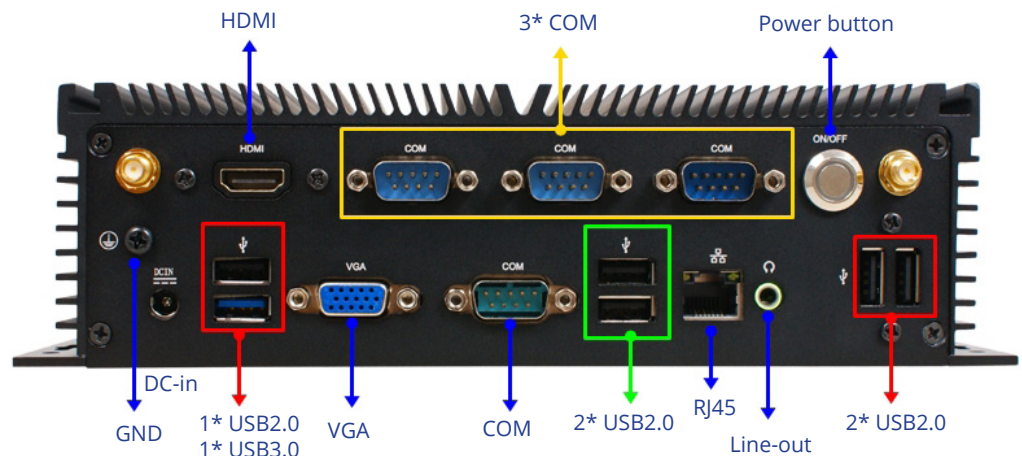

Specifications

Processor	Intel® Bay Trail-D J1900 SoC Processor	Power	12V DC Power in DC-12V_60W Adapter
Chipset	SoC	Temperature	Operating : -10°C~60°C Storage : -20°C~70°C
Memory	1* DDR3L SO-DIMM up to 8GB	Material	Aluminum heatsink & steel plane integration structure
Ethernet	1* RTL8111G GbE	Structure	
Display Output	1* VGA,1* HDMI	Dimension	200(D) x 234(W) x 64.5(H) mm
Storage	1* mSATA (full size), 1* 2.5" Device		
Expansion Slot	1* Mini PCIe		
Front I/O	N/A		
Rear I/O	1* USB3.0, 5* USB2.0, 4* RS232 (COM1/2 support 5V/12V), 1* VGA, 1* HDMI, 1* RJ45, 1* Line-out, 1* DC Jack, 1* Power Button		

*The Specification may be changed without further notice.
www.jetwayipc.com

HBFEF752-7200-B

Features



- Intel Kabylake-U Core-i Series Processor
- 2* DDR4 2133MHz SO-DIMM up to 32GB
- 4* USB 2.0, 4* USB 3.0, 1* HDMI, 1* VGA , 1* LVDS, 2* RJ45, 8* POE, 4* COM, 2* GPIO, 1* MIC, 1* Line out
- DC 9~36V INPUT Support (for SYSTEM)
- DC 48~52V INPUT Support (for POE only)
- **Vehicle Fanless System Application**



Front IO

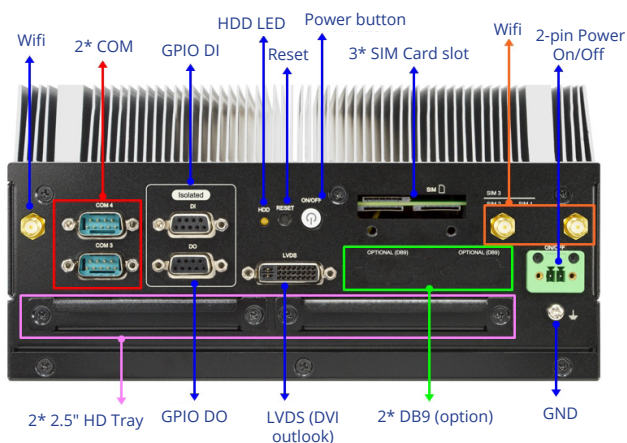

Rear IO

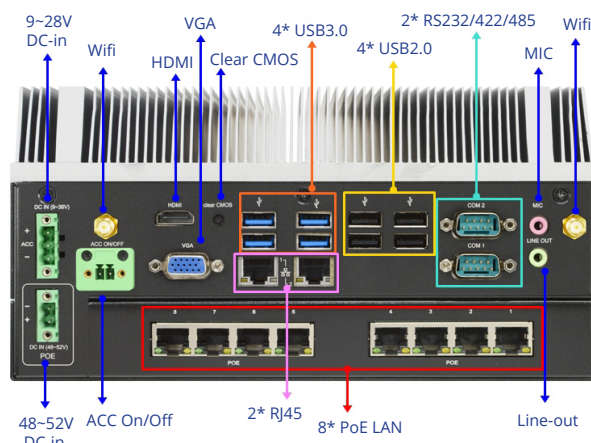

Specifications

Processor	Intel® Kabylake-U Core-i Series Processor	Power	DC 9~36V for SYSTEM (Phoenix terminal)
Chipset	SoC		DC 48~52V for POE LAN (Phoenix terminal)
Memory	2* SO-DIMM slots DDR4 2133MHz up to 32GB	Temperature	Operating : -20°C~70°C Storage : -20°C~70°C
Ethernet	2* Intel® GbE Lan (1 x i219LM, 1 x i210AT)	Material	Aluminum heatsink &
Display Output	1* HDMI, 1* VGA , 1* LVDS	Structure	steel plane integration structure
Storage	1* mSATA (full size shared), 2* 2.5" Device	Dimension	231(D) x 232(W) x103(H) mm
Expansion Slot	2* Mini-PCIe (full size, for WiFi & CAN BUS expansion) 1* Mini-PCIe slot (USB only , full size, for 4G LTE + GPS expansion)		
Front I/O	1* Power button, 1* Reset button, 1* Power LED, 1* HDD LED, 2* COM, 2* GPIO 1* CAN Bus, 1* LVDS out, 3* SIM Card		
Rear I/O	4* USB 2.0, 4* USB 3.0, 1* HDMI, 1* VGA, 2* RJ45, 8* POE LAN, 1* Line-out, 1* MIC, 2* COM, 1* DC 9~36V - In, 1* DC 52V - In, 1* Clear COMS		

*The Specification may be changed without further notice.
www.jetwayipc.com

HBF752-7200-B

Features



- Intel® Kabylake-U Core-i series Processor
- 2* DDR4 2133MHz SO-DIMM up to 32GB
- 4* USB 2.0, 4* USB 3.0, 1* HDMI, 1* VGA, 1* LVDS, 2* RJ45, 4* COM, 2* GPIO, 1* MIC, 1* Line out
- DC-12V_60W Adapter
- Industrial Automation Control Fanless System Application



Front IO

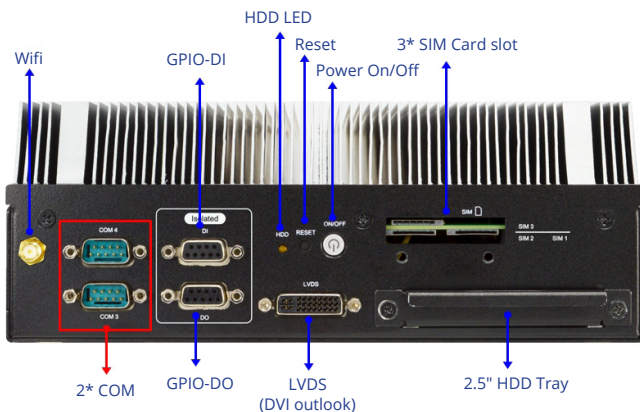

Rear IO

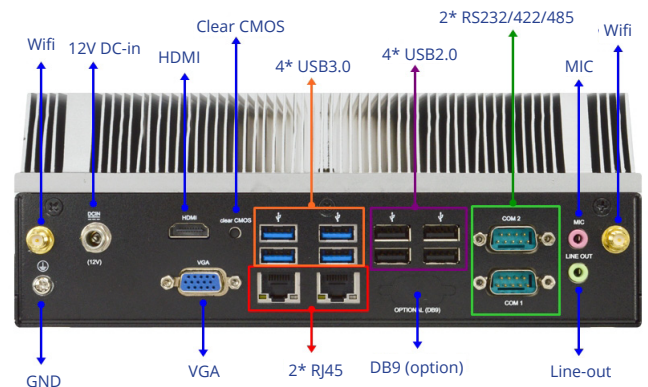

Specifications

Processor	Intel® Kabylake-U Core-i series Processor	Power	12V DC Power in DC-12V_60W Adapter
Chipset	SoC	Temperature	Operating : -20°C~70°C Storage : -20°C~70°C
Memory	2* SO-DIMM slots DDR4 2133MHz up to 32GB	Material	Aluminum heatsink &
Ethernet	2* Intel® GbE Lan (1 x i219LM , 1 x i210AT)	Structure	steel plane integration structure
Display Output	1* HDMI, 1* VGA, 1* LVDS	Dimension	231(D) x 232(W) x88(H) mm
Storage	1* mSATA (full size shared), 1* 2.5" Device		
Expansion Slot	2* Mini-PCIe (full size, for WiFi expansion), 1* Mini-PCIe slot (USB only, full size, for 4G LTE + GPS expansion)		
Front I/O	1* Power button, 1* Reset button, 1* Power LED, 1* HDD LED 2* COM, 2* GPIO, 1* LVDS out, 2* SIM Card		
Rear I/O	4* USB 2.0, 4* USB 3.0, 1* HDMI, 1* VGA, 2* RJ45, 1* Line-out, 1* MIC 2* COM, 1* DC Jack, 1* Clear COMS		

*The Specification may be changed without further notice.
www.jetwayipc.com

HBJC130F533M4-19G Series



Features



- Intel® Bay Trail-D J1900 Processor
- On board 4GB DDR3L 1333MHz
- 1* VGA, 1* COM, 3* Mini PCI Express, 3* SIM Card (Max), 6* RJ45 (Max)
- M/B Form Factor : 3.5" (148x102mm)
- DC-12V_60W Adapter

Specifications

Processor	Intel® Bay Trail-D J1900 Processor	Power	12V DC Power in DC-12V_60W Adapter
Chipset	SoC	Temperature	Operating : 0°C~50°C Storage : -10°C~70°C
Memory	Onboard 4GB DDR3L 1333MHz	Material	Steel plane integration structure
Ethernet	4* Intel i211AT GbE	Structure	
Display Output	1* VGA	Dimension	152(D) x 232(W) x 44(H) mm
Storage	1* mSATA (full size shared), 1* 2.5" Device		
Expansion Slot	3* Mini PCI Express (full size), 3* SIM Card (Max)		
Front I/O	1* COM, 1* USB 3.0, 1* USB 2.0, 1* Power LED, 1* HDD LED, 6* RJ45 (Max)		
Rear I/O	1* Power Button, 1* VGA, 1* DC Jack		

HBJC130F533MXXXXG

4 : RJ45 * 4
 4Z : RJ45 * 4 + WIFI
 6 : RJ45 * 6
 6Z : RJ45 * 6 + WIFI

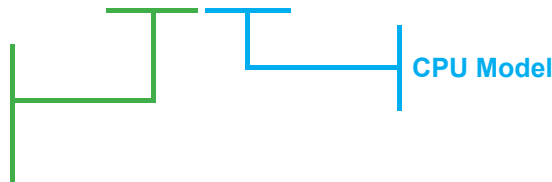

*The Specification may be changed without further notice.
www.jetwayipc.com

HBJC130F533M4-19G

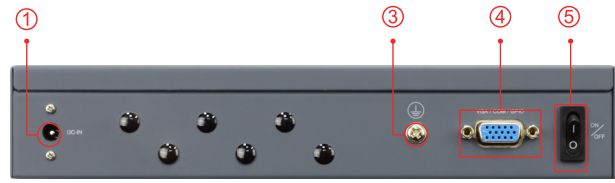
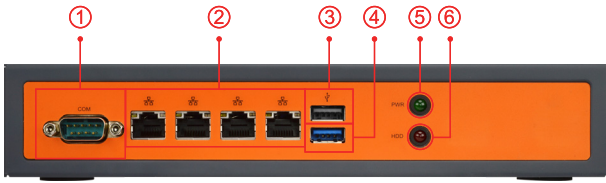

HBJC130F533M6-19G

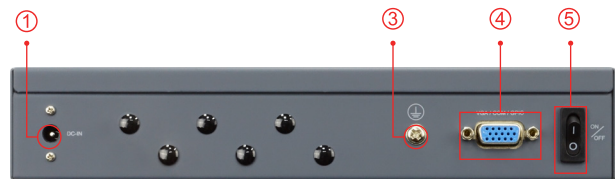
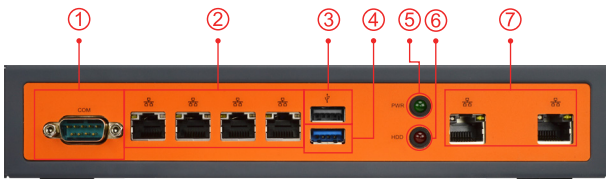

HBJC130F533M4Z19G

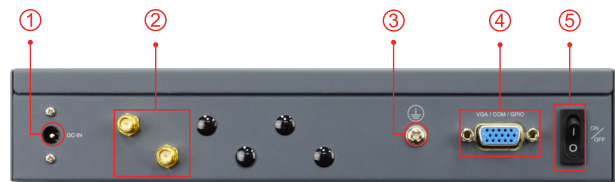
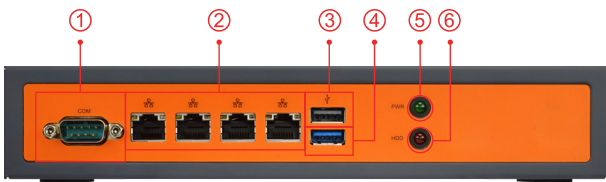

HBJC130F533M6Z19G

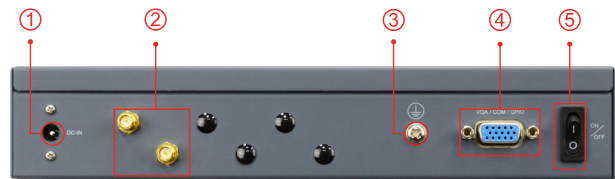
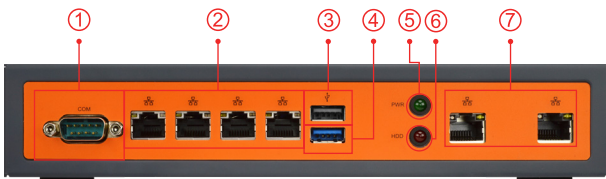

Front IO

- | | | |
|------------|------------|---------|
| 1. COM | 4. USB 3.0 | 7. RJ45 |
| 2. RJ45 | 5. PW LED | |
| 3. USB 2.0 | 6. HDD LED | |

Rear IO

- | | | |
|----------|--------|--------------|
| 1. DC-in | 3. GND | 5. PW button |
| 2. WiFi | 4. VGA | |

*The Specification may be changed without further notice.
www.jetwayipc.com

HBJC130F73104-38G Series



Features



- Intel® Skylake Celeron 3855U/3955U Processor
- 1* SO-DIMM DDR4 2133MHz up to 16GB
- 1* HDMI, 2 * COM (Max.), 2* Mini PCI Express, 1* SIM Card Slot,
- 4* RJ45, 2* USB 3.0
- M/B Form Factor : 3.5" (148x102mm)
- DC-12V_60W Adapter

Specifications

Processor	Intel® Skylake Celeron 3855U/3955U Processor	Power	12V DC Power in DC-12V_60W Adapter
Chipset	SoC	Temperature	Operating : 0°C~50°C Storage: -10°C~70°C
Memory	1* DDR4 2133MHz SO-DIMM up to 16GB	Material	Steel plane integration structure
Ethernet	3* Intel i211AT & 1* Intel i219LM GbE	Structure	
Display Output	1* HDMI	Dimension	152(D) x 232(W) x 44(H) mm
Storage	1* mSATA (full size), 1* 2.5" Device		
Expansion Slot	2* Mini PCI Express (full & half size)		
Front I/O	1* COM, 2* USB 3.0, 1* Power LED, 1* HDD LED, 4* RJ45		
Rear I/O	1* Power Button, 1* HDMI, 1* DC Jack		

HBJC130F731 **XX** - **3XX** G

04 : RJ45 * 4
 Z4 : RJ45 * 4 + WIFI
 06 : RJ45 * 6
 Z6 : RJ45 * 6 + WIFI

CPU Model
 38 : 3855
 396 : 3965

*The Specification may be changed without further notice.
www.jetwayipc.com

PICO-ITX
 J10
 NUC
 uTX
 3.5"
 Mini-ITX
 Desktop
 Network
 Expand
 Proof
 WT
 WV
 Hummer
 ARM

HBJC130F73104-38G / HBJC130F73104-396G

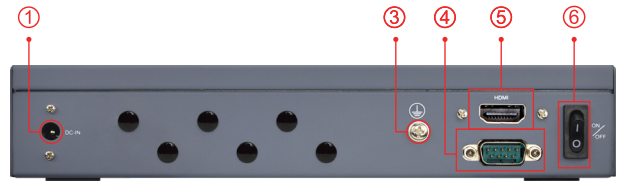
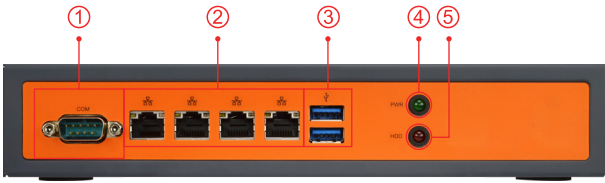

HBJC130F73106-38G / HBJC130F73106-396G

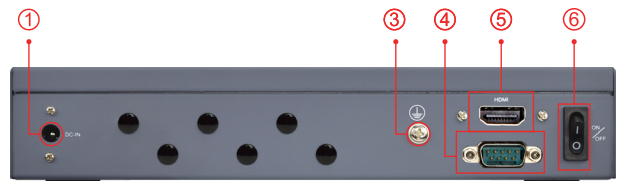
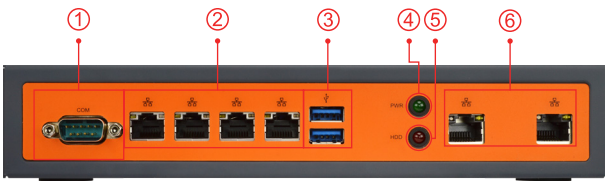

HBJC130F731Z4-38G / HBJC130F731Z4-396G

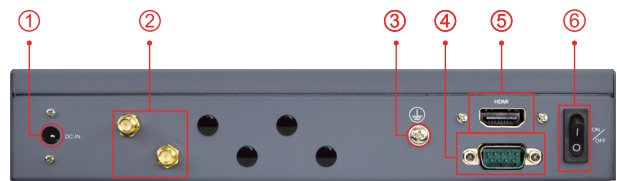
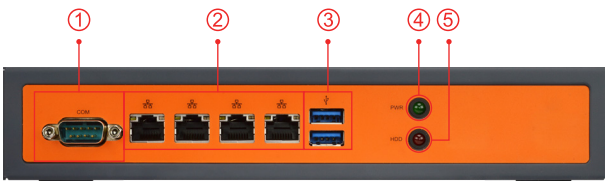

HBJC130F731Z6-38G / HBJC130F731Z6-396G

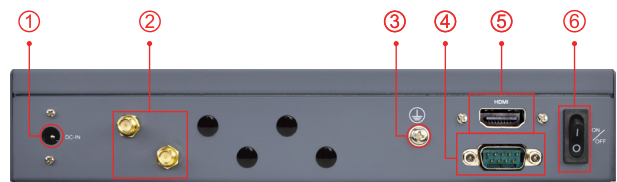
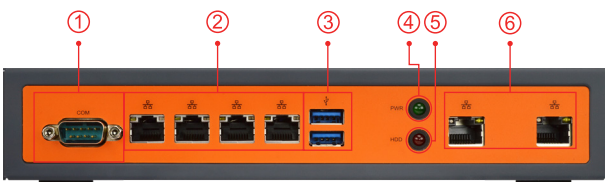

Front IO

- | | | |
|---------|------------|------------|
| 1. COM | 3. USB 3.0 | 5. HDD LED |
| 2. RJ45 | 4. PW LED | 6. RJ45 |

Rear IO

- | | | |
|----------|---------|--------------|
| 1. DC-in | 3. GND | 5. COM |
| 2. WiFi | 4. HDMI | 6. PW button |

*The Specification may be changed without further notice.
www.jetwayipc.com

HBJC141F9HG04-29B

Features



- Intel BayTrail-M N2930 Processor
- 2* DDR3L 1333MHz SO-DIMM up to 8GB
- 1* VGA, 4* RJ45, 1* USB 3.0, 1* USB 2.0, 2* COM
- M/B Form Factor : Thin Mini ITX (170x170mm)
- DC-12V_60W Adapter



Front IO

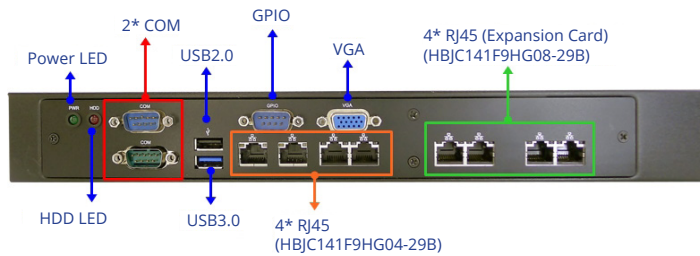

Rear IO



Specifications

Processor	Intel® BayTrail-M N2930 Processor	Power	12V DC Power in DC-12V_60W Adapter
Chipset	SoC	Temperature	Operating : 0°C~50°C Storage : -10°C~70°C
Memory	2* DDR3L 1333MHz SO-DIMM up to 8GB	Material	Steel plane integration structure
Ethernet	4* Intel i211AT GbE	Structure	
Display Output	1* VGA	Dimension	192(D) x 330(W) x 44(H) mm
Storage	1* mSATA (full size), 1* 2.5" Device		
Expansion Slot	1* Mini PCI Express (full size)		
Front I/O	2* COM, 1* USB 3.0, 1* USB 2.0, 1* Power LED, 1* HDD LED, 4* RJ45		
Rear I/O	1* Power Button, 1* DC Jack		

*The Specification may be changed without further notice.
www.jetwayipc.com

PICO-ITX
J10
NUC
uTX
3.5"
Mini-ITX
Desktop
Network
Expand
Proof
WT
WV
Hummer
ARM

HBJC141F9HG08-29B

Features



- Intel BayTrail-M N2930 Processor
- 2* DDR3L 1333MHz SO-DIMM up to 8GB
- 1* VGA, 8* RJ45, 1* USB 3.0,
1* USB 2.0, 2* COM
- M/B Form Factor : Thin Mini ITX
(170x170mm)
- DC-12V_60W Adapter



Front IO

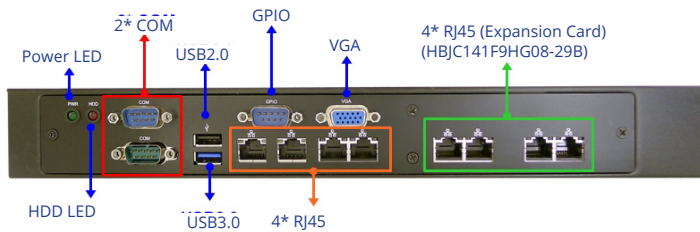

Rear IO



Specifications

Processor	Intel® BayTrail-M N2930 Processor	Power	12V DC Power in DC-12V_60W Adapter
Chipset	SoC	Temperature	Operating : 0°C~50°C Storage : -10°C~70°C
Memory	2* DDR3L 1333MHz SO-DIMM up to 8GB	Material	Steel plane integration structure
Ethernet	8* Intel i211AT GbE	Structure	
Display Output	1* VGA	Dimension	192(D) x 330(W) x 44(H) mm
Storage	1* mSATA (full size), 1* 2.5" Device		
Expansion Slot	1* Mini PCI Express (full size)		
Front I/O	2* COM, 1* USB 3.0, 1* USB 2.0, 1* Power LED, 1* HDD LED, 8* RJ45		
Rear I/O	1* Power Button, 1* DC Jack		

*The Specification may be changed without further notice.
www.jetwayipc.com

HBJC141F692 Series

Features



- Intel® Apollo Lake Series Processor
- 1* DDR3L 1866MHz SO-DIMM up to 8GB
- 2* USB 3.0, 6* RJ45, 1* RS232 (RJ45 Type)
- M/B Form Factor : Mini ITX (170x170mm)
- DC_12V 60W Adapter



Front IO

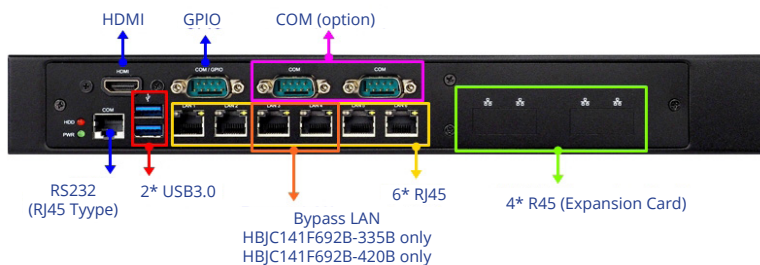

Rear IO



Specifications

Processor	Intel® Apollo Lake Series Processor	Power	12V DC Power in DC-12V_60W Adapter
Chipset	SoC	Temperature	Operating : 0°C~50°C Storage : -10°C~70°C
Memory	1* DDR3L 1866MHz SO-DIMM up to 8GB	Material	Steel plane integration structure
Ethernet	6* Intel i211AT Gigabit LAN	Structure	
Display Output	1* HDMI	Dimension	192(D) x 330(W) x 44(H) mm
Storage	1* mSATA (full size), 1* 2.5" Device		
Expansion Slot	1* Mini PCI Express (full size)		
Front I/O	2* USB 3.0, 1* Power LED, 1* HDD LED, 6* RJ45, 1* COM (RJ45 Type)		
Rear I/O	1* Power Button, 1* DC Jack		

*The Specification may be changed without further notice.
www.jetwayipc.com

PICO-ITX
J10
NUC
uTX
3.5"
Mini-ITX
Desktop
Network
Expand
Proof
WT
WV
Hummer
ARM

HBJC142F695-345B

Features



- Intel® Apollo Lake J3455 SoC Processor (TDP 10W)
- 1* DDR3L 1866MHz SO-DIMM up to 8GB
- 2 * USB2.0, 4 * USB3.0, 2 * HDMI, 1 * RJ45, 1* GPIO
- M/B Form Factor : Mini ITX (170x170mm)
- DC-12V Adapter



Front IO



Rear IO

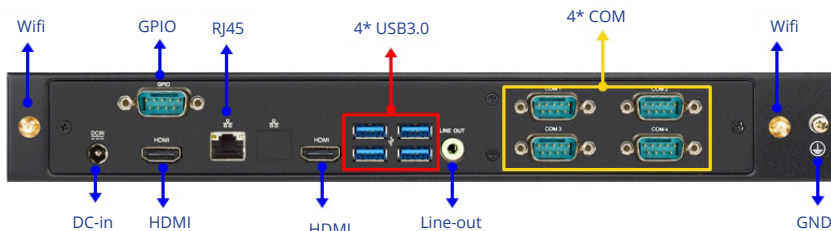

Specifications

Processor	Intel® Apollo Lake J3455 SoC Processor	Power	12V DC Power in DC-12V_60W Adapter
Chipset	Intel J3455 chipset	Temperature	Operating : 0°C~50°C Storage : -10°C~70°C
Memory	1* DDR3L 1866MHz SO-DIMM up to 8GB	Material	Steel plane integration structure
Ethernet	1* Realtek 8111H GbE	Structure	
Display Output	2* HDMI	Dimension	192(D) x 330(W) x 44(H) mm
Storage	1* M.2 (2242/2260), 1* 3.5" SATA		
Expansion Slot	1* GPIO, 4* COM (COM1: RS232/422/485), 1* TPM (1.2/2.0 optional)		
Front I/O	1* Power button, 1* Reset button, 2* USB2.0, 1* Power LED , 1* HDD LED		
Rear I/O	4* USB3.0, 1* GbE, 2* HDMI, 1* Line out, 1* DC jack		

*The Specification may be changed without further notice.
www.jetwayipc.com

HBJC142F791-3955B Series

Features



- Intel® Skylake Celeron 3855U/3955U Processor
- 2* DDR4 2133MHz SO-DIMM up to 32GB
- 1* HDMI, 1* VGA, 2* RJ45, 4* USB 3.0, 2* USB 2.0, 5* COM (Max.), 1* LPT, 1* RJ11
- M/B Form Factor : Mini ITX (170x170mm)
- DC-12V_60W Adapter



Front IO



Rear IO

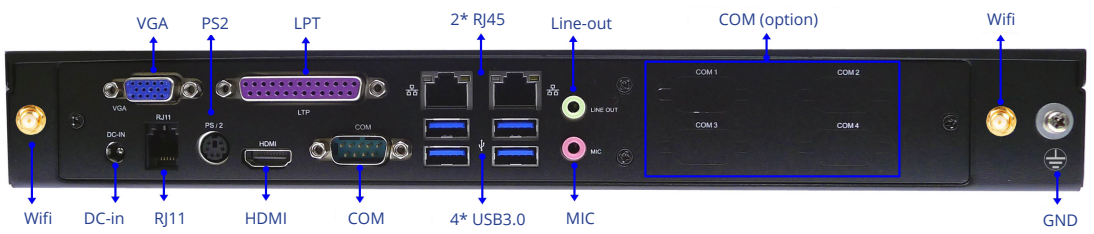

Specifications

Processor	Intel® Skylake Celeron 3855U/3955U Processor	Power	12V DC Power in DC-12V_60W Adapter
Chipset	SoC	Temperature	Operating : 0°C~50°C Storage : -10°C~70°C
Memory	2* DDR4 2133MHz SO-DIMM up to 32GB	Material	Steel plane integration structure
Ethernet	2* Realtek RTL8111H GbE	Structure	
Display Output	1* HDMI, 1* VGA	Dimension	192(D) x 330(W) x 44(H) mm
Storage	1* mSATA (full size), 1* 2.5" Device		
Expansion Slot	2* Mini PCI Express (full size)		
Front I/O	1* Power LED, 1* HDD LED, 1* Power Button, 2* USB 2.0		
Rear I/O	4* USB 3.0, 2* RJ45, 1* HDMI, 1* VGA, 5* COM (Max.), 1* LPT, 1* RJ11, 1* PS/2, 1* Line out, 1* MIC, 1* DC Jack		

*The Specification may be changed without further notice.
www.jetwayipc.com

PICO-ITX
J10
NUC
uTX
3.5"
Mini-ITX
Desktop
Network
Expand
Proof
WT
WV
Hummer
ARM

HBJC143F693-H110-B

Features



- Intel® LGA1151 Socket Processor with H110 chipset (max.65W)
- 2* DDR4-2133Mhz SO-DIMM up to 32GB
- 2* USB2.0, 4* USB3.0, 1* HDM, 1* DP, 2* RJ45, 1* MIC, 1* Line in, 1* Line out
- M/B Form Factor : Mini ITX (170x170mm)
- AC Power Socket, 1U 200W FLEX Power



Front IO

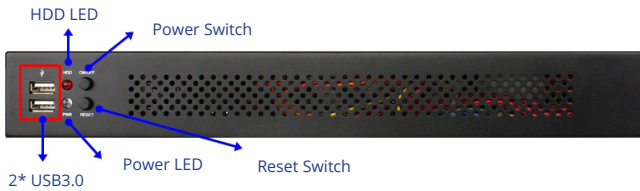

Rear IO

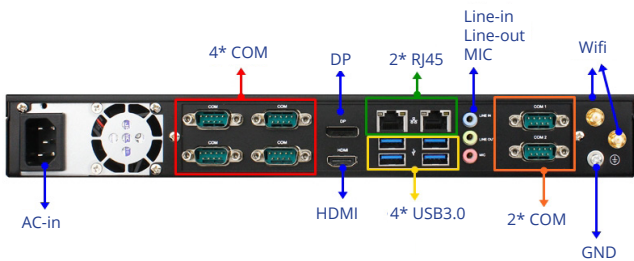

Specifications

Processor	Intel® LGA1151 Socket Core i3,i5,i7 & Pentium Processors	Power	90V~240V AC Power in 200W FLEX Power inside
Chipset	Intel H110 chipset	Temperature	Operating : 0°C~50°C Storage : -10°C~70°C
Memory	2* DDR4 2133MHz SO-DIMM up to 32GB	Material	Steel plane integration structure
Ethernet	2* Realtek® 8111H Gigabit LAN	Structure	
Display Output	1* HDMI, 1* DP	Dimension	192(D) x 330(W) x 44(H) mm
Storage	1* M.2 (M key-2242), 1* 2.5" Device		
Expansion Slot	1* Mini PCI Express (full size)		
Front I/O	1* Power LED, 1* HDD LED, 1* Power Button, 2* USB 2.0		
Rear I/O	4* USB 3.0, 2* RJ45, 1* HDMI, 1* DP, 6* COM (Max.), 1* Line out, 1* MIC, 1* AC IN		

*The Specification may be changed without further notice.
www.jetwayipc.com

HBJC143F694-335B

Features



- Intel® Apollo Lake SoC Processor
- 1* DDR3L 1866MHz SO-DIMM up to 8GB
- 4* COM, 4* USB 3.0, 1* HDMI, 1* DP, 1* RJ45, 1* MIC, 1* Line in, 1* Line out
- M/B Form Factor : Mini ITX (170x170mm)
- 1U 200W FLEX Power



Front IO

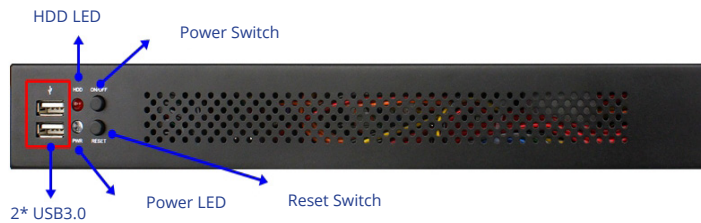

Rear IO

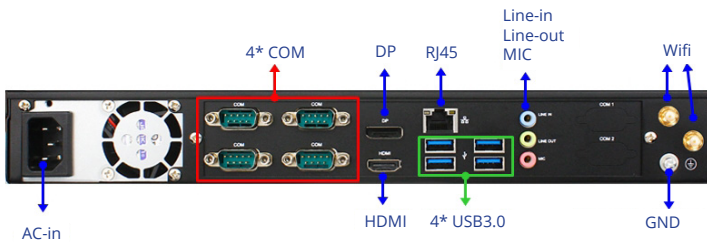

Specifications

Processor	Intel® Apollo Lake N3350/N4200 Processor	Power	90V~240V AC Power in 200W FLEX Power inside
Chipset	SoC	Temperature	Operating : 0°C~50°C Storage : -10°C~70°C
Memory	1* DDR3L 1866MHz SO-DIMM up to 8GB	Material	Steel plane integration structure
Ethernet	1* Realtek® 8111H Gigabit LAN	Structure	
Display Output	1* HDMI, 1* DP	Dimension	192(D) x 330(W) x 44(H) mm
Storage	1* M.2 (M key-2242), 1* 2.5" Device		
Expansion Slot	1* Mini PCI Express (full size)		
Front I/O	1* Power LED, 1* HDD LED, 1* Power Button, 2* USB 2.0		
Rear I/O	4* USB 3.0, 1* RJ45, 1* HDMI, 1* DP, 4* COM (Max.), 1* Line out, 1* Line in, 1* MIC, 1* AC IN		

*The Specification may be changed without further notice.
www.jetwayipc.com

PICO-ITX
J10
NUC
uTX
3.5"
Mini-ITX
Desktop
Network
Expand
Proof
WT
WV
Hummer
ARM

HBJC143F892-H110B

Features



- Intel® Skylake/Kabylake Processor
- 2* DDR4 2133MHz SO-DIMM up to 32 GB
- 2* USB 2.0, 4* USB 3.0, 1* HDMI, 4* RJ45, 1* PS2, 1* COM, 1* Line out
- M/B Form Factor : Mini ITX (170x170mm)
- 1U 200W FLEX POWER



Front IO

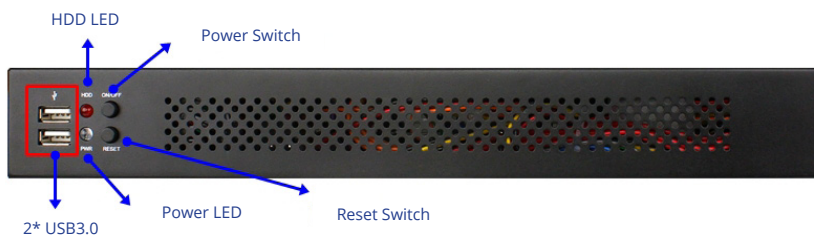

Rear IO

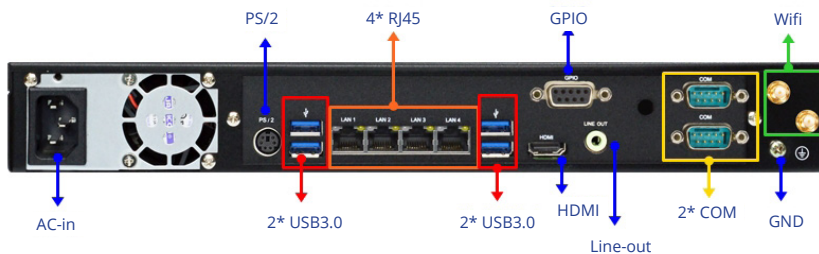

Specifications

Processor	Intel® LGA1151 Skylake/Kabylake Processor (TDP 65W)	Power	90V~240V AC Power in 200W FLEX Power inside
Chipset	Intel® H110 chipset	Temperature	Operating : 0°C~50°C Storage : -10°C~70°C
Memory	2* DDR4 2133MHz SO-DIMM up to 32 GB	Material	Steel plane integration structure
Ethernet	4* Intel Gigabit LAN (1* i219LM, 3* i211AT)	Structure	
Display Output	1* HDMI	Dimension	192(D) x 330(W) x 44(H) mm
Storage	1* mSATA (full size), 1* 2.5" Device		
Expansion Slot	1* Mini PCI Express (half size), 1* M.2 (E-key 2230)		
Front I/O	1* Power LED, 1* HDD LED, 1* Power button, 1* Reset button, 2* USB 2.0		
Rear I/O	4* USB 3.0, 1* HDMI, 4* RJ45, 1* PS2, 1* COM, 1* Line out, 1* AC input		

*The Specification may be changed without further notice.
www.jetwayipc.com

HBJC375F533M-19B4

Features



- Intel® BayTrail J1900 Processor
- 1* DDR3L 1333MHz SODIMM up to 8GB
- 1* VGA, 4* RJ45, 3* USB2.0, 1* USB3.0, 2* COM
- M/B Form Factor : 3.5" (148x102mm)
- DC-12V_60W Adapter



Front IO



Rear IO

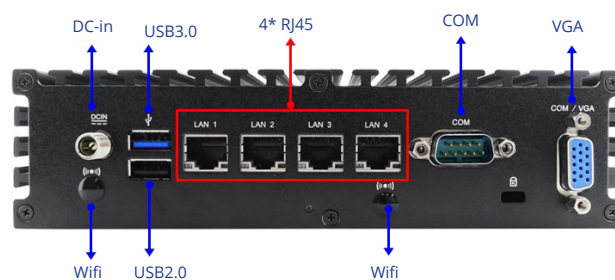

Specifications

Processor	Intel® BayTrail-D J1900 Processor	Power	12V DC Power in DC-12V_60W Adapter
Chipset	SoC	Temperature	Operating : 0°C~50°C Storage : -10°C~70°C
Memory	1* DDR3L 1333MHz SO-DIMM up to 8GB	Material	Aluminum heatsink &
Ethernet	4* Intel i211AT GbE	Structure	steel plane integration structure
Display Output	1* VGA	Dimension	142(D) x 185(W) x 48(H) mm
Storage	1* M.2-2242 (M-key), 1* 2.5" Device		
Expansion Slot	1* Mini PCI Express (full-size)		
Front I/O	1* Power LED, 1* HDD LED, 1* Power Button, 1* Reset button, 2* USB 2.0, 4* LAN LED, 1* COM		
Rear I/O	1* USB 3.0, 1* USB 2.0, 1* VGA, 4* RJ45, 1* COM, 1* DC Jack		

*The Specification may be changed without further notice.
www.jetwayipc.com

HBJC385F551 Series

Features



- Intel® Skylake i5-6200U/6300U Processor
- 2* DDR4 2133MHz SO-DIMM up to 32GB
- 2* DP, 6* RJ45, 4* USB 3.0, 2* USB 2.0, 1* COM (RJ45 Type), 1* COM, 1* GPIO
- M/B Form Factor : 138x166mm
- DC-12V_60W Adapter



Front IO

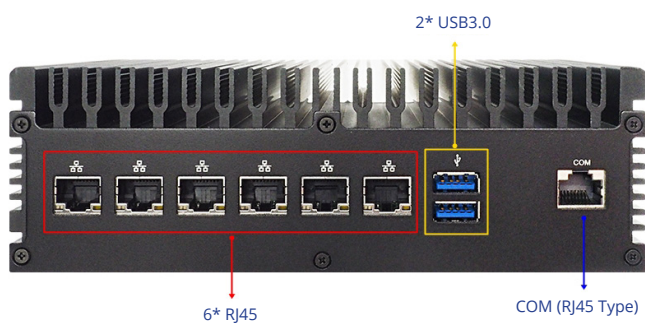

Rear IO



Specifications

Processor	Intel® Skylake i5-6200U/6300U Processor	Power	12V DC Power in DC-12V_60W Adapter
Chipset	SoC	Temperature	Operating : 0°C~50°C Storage : -10°C~70°C
Memory	2* DDR4 2133MHz SO-DIMM up to 32GB	Material	Aluminum heatsink &
Ethernet	3* Intel GbE (i211AT, i219LM, i350AM4)	Structure	steel plane integration structure
Display Output	2* DP	Dimension	142(D) x 185(W) x 60(H) mm
Storage	1* mSATA (full size shared), 1* 2.5" Device		
Expansion Slot	2* Mini PCI Express (full size)		
Front I/O	2* USB 3.0, 1* COM (RJ45 Type), 6* RJ45		
Rear I/O	1* Power LED, 1* HDD LED, 1* Power Button, 1* Reset button, 2* USB 3.0, 2* USB 2.0, 2* DP, 1* COM (option), 1* GPIO, 1* DC jack		

*The Specification may be changed without further notice.
www.jetwayipc.com

HBFD731-3855-B Series

Features



- Intel® Skylake Celeron 3855U/3955U Processor
- 1* DDR4 2133MHz SO-DIMM up to 16GB
- 1* HDMI, 4* RJ45, 2* USB 3.0, 2* USB 2.0, 2* COM (Max.)
- M/B Form Factor : 3.5" (148x102mm)
- DC-12V_60W Adapter



Front IO

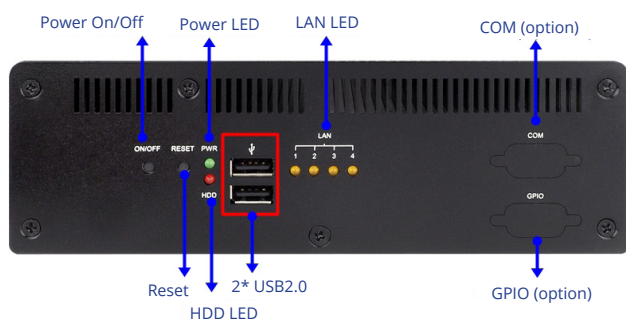

Rear IO

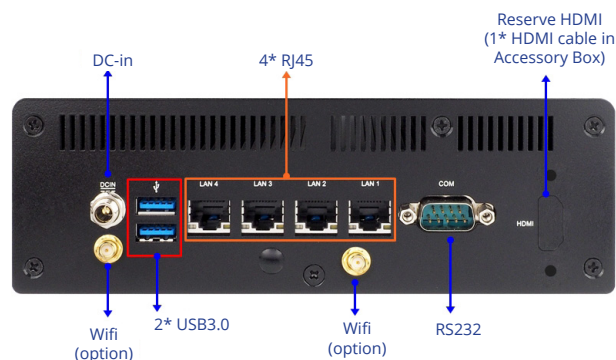

Specifications

Processor	Intel® Skylake Celeron 3855U/3955U Processor	Power	12V DC Power in DC-12V_60W Adapter
Chipset	SoC	Temperature	Operating : 0°C~50°C Storage : -10°C~70°C
Memory	1* DDR4 2133MHz SO-DIMM up to 16GB	Material	Aluminum heatsink &
Ethernet	3* Intel i211AT & 1* Intel i219LM GbE	Structure	steel plane integration structure
Display Output	1* HDMI	Dimension	142.5(D) x 193(W) x 62(H) mm
Storage	1* mSATA (full size), 1* 2.5" Device		
Expansion Slot	2* Mini PCI Express (full & half size)		
Front I/O	1* Power LED, 1* HDD LED, 1* Power Button, 1* Reset button, 2* USB 2.0 , 4* NIC LEDs, 1* Reserved COM, 1* GPIO		
Rear I/O	2* USB 3.0, 4* RJ45, 1* HDMI, 1* COM, 1* DC jack		

*The Specification may be changed without further notice.
www.jetwayipc.com

Note :

PICO-ITX

J10

NUC

uTX

3.5"

Mini-ITX

Desktop

Network

Expand

Proof

WT

WV

Hummer

ARM

*The Specification may be changed without further notice.
www.jetwayipc.com

HBJC38AF542 Series



Features



- Intel® Haswell i5-4300U/Broadwell i5-5200U Processor
- 2* DDR3L 1600MHz SO-DIMM up to 16GB
- Rear IO: 1* HDMI, 1* DP, 2* RJ45, 2* COM, 2* USB3.0, 2* USB 2.0, 1* Line out/ MIC
- Front I/O : Different interfaces such as USB 3.0 & GPIO & COM & LAN can be selected
- Cableless & Expandable Design
- M/B Form Factor : 110x166mm
- DC-12V_60W Adapter

Specifications

Processor	Intel® Haswell i5-4300U/Broadwell 4300U Processor	Power	12V DC Power in DC-12V_60W Adapter
Chipset	SoC	Temperature	Operating : 0°C~50°C Storage : -10°C~70°C
Memory	2* DDR3L 1600MHz SO-DIMM up to 16GB	Material	Aluminum heatsink &
Ethernet	1* Intel i211AT & 1* Intel i218LM GbE	Structure	steel plane integration structure
Display Output	1* HDMI, 1* DP	Dimension	175(D) x 185(W) x 60(H) mm
Storage	1* mSATA (full size shared), 1* 2.5" Device		
Expansion Slot	2* Mini PCI Express (full size)		
Front I/O	1* Power LED, 1* HDD LED, 1* Power Button (Different interfaces such as 8* USB 3.0 & 32 bit GPIO & 8* COM & 8* LAN can be selected)		
Rear I/O	2* USB 3.0, 2* USB 2.0, 2* RJ45, 1* HDMI, 1* DP, 2* COM , 1* MIC , 1* Line out, 1* Reset button, 1* DC jack		

Rear IO

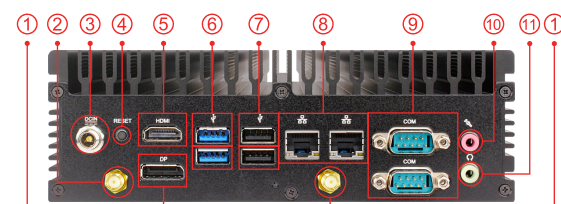

- | | | |
|-----------------|------------|-------------|
| 1. WiFi | 5. USB 2.0 | 9. Line out |
| 2. DC-in | 6. HDMI | 10. Line in |
| 3. Reset button | 7. RJ45 | 11. VGA |
| 4. USB 3.0 | 8. COM | |

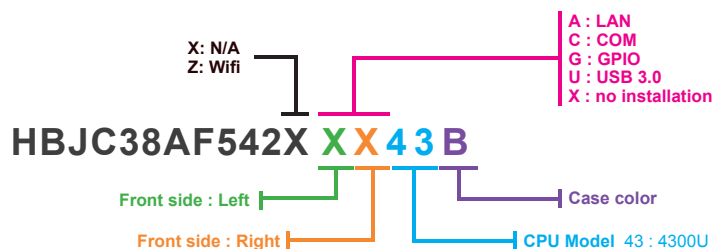

*The Specification may be changed without further notice.
www.jetwayipc.com

PICO-ITX
J10
NUC
uTX
3.5"
Mini-ITX
Desktop
Network
Expand
Proof
WT
WV
Hummer
ARM

Front IO

HBJC38AF542(Z)XX43B

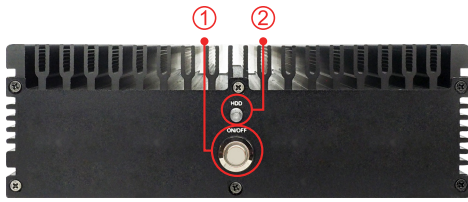

HBJC38AF542(Z)XA43B

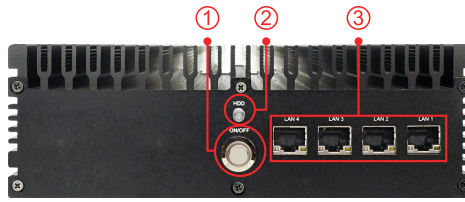

HBJC38AF542(Z)CX43B

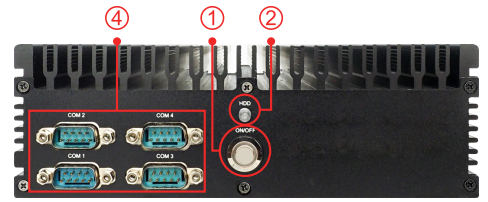

HBJC38AF542(Z)XU43B

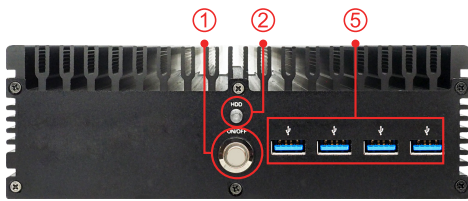

HBJC38AF542(Z)XG43B

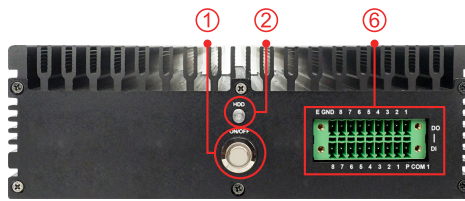

HBJC38AF542(Z)CA43B

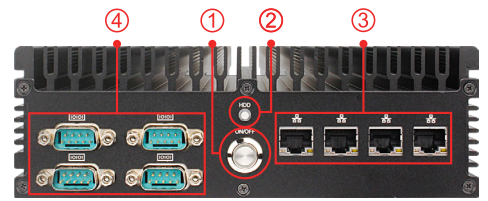

HBJC38AF542(Z)CU43B

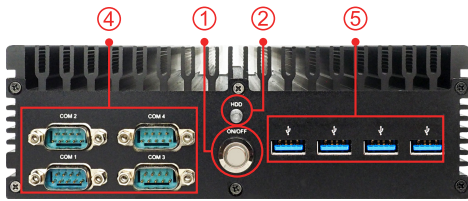

HBJC38AF542(Z)CG43B

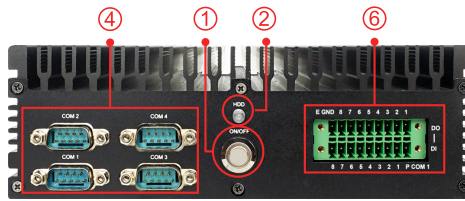

HBJC38AF542(Z)AA43B

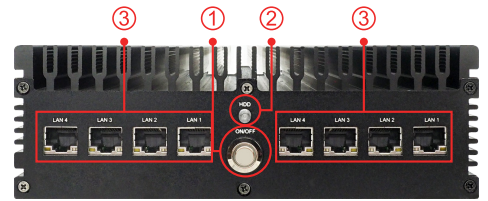

HBJC38AF542(Z)CC43B

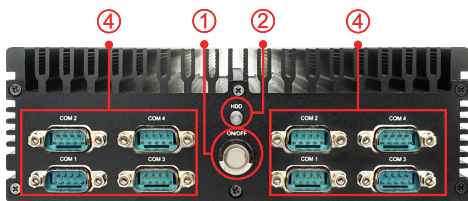

HBJC38AF542(Z)AU43B

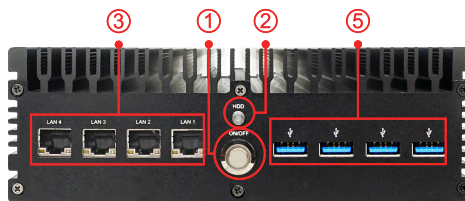

HBJC38AF542(Z)AG43B

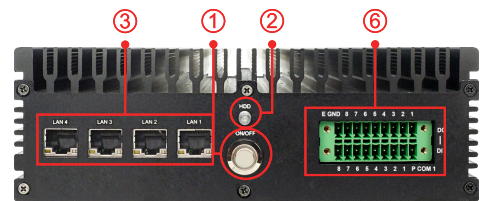

HBJC38AF542(Z)GG43B

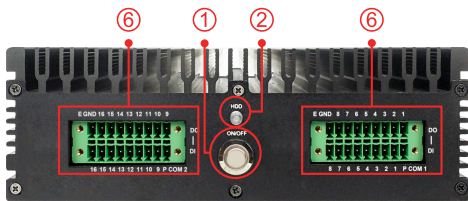

HBJC38AF542(Z)GU43B

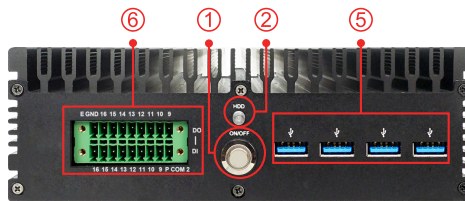

1. PW button
2. HDD LED
3. RJ45(LAN)
4. COM
5. USB 3.0
6. GPIO

*The Specification may be changed without further notice.
www.jetwayipc.com

PICO-ITX
J10
NUC
uTX
3.5"
Mini-ITX
Desktop
Network
Expand
Proof
WT
WV
Hummer
ARM

HBJC390F541 Series



Features



- Intel® BayTrail-D J1900 Processor
- 1* DDR3L 1333MHz SO-DIMM up to 8GB
- Rear I/O : 1* HDMI, 1* VGA, 2* RJ45, 1* COM, 1* USB 3.0, 3* USB 2.0, 1* Line out, 1* MIC
- Front I/O : Different interfaces such as USB 3.0 & GPIO & COM & LAN can be selected
- Cableless & Expandable Design
- M/B Form Factor : 100x166mm
- DC-12V_60W Adapter

Specifications

Processor	Intel® BayTrail-D J1900 Processor	Power	12V DC Power in DC-12V_60W Adapter
Chipset	SoC	Temperature	Operating : 0°C~50°C Storage : -10°C~70°C
Memory	1* DDR3L 1333MHz SO-DIMM up to 8GB	Material	Aluminum heatsink &
Ethernet	2* Intel i211AT GbE	Structure	steel plane integration structure
Display Output	1* HDMI, 1* VGA	Dimension	165(D) x 185(W) x 48(H) mm
Storage	1* mSATA (full size shared), 1* 2.5" Device		
Expansion Slot	2* Mini PCI Express (full size)		
Front I/O	1* Power LED, 1* HDD LED, 1* Power Button (Different interfaces such as 8* USB 3.0 & 32 bit GPIO & 8* COM & 8* LAN can be selected)		
Rear I/O	1* USB 3.0, 3* USB 2.0, 2 * RJ45, 1* HDMI, 1* VGA, 1* COM, 1* Line out, 1* MIC, 1* Reset button, 1* DC jack		

Rear IO

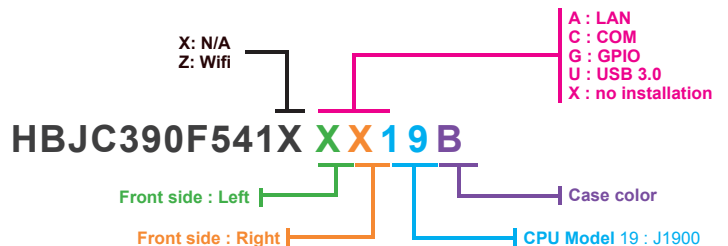
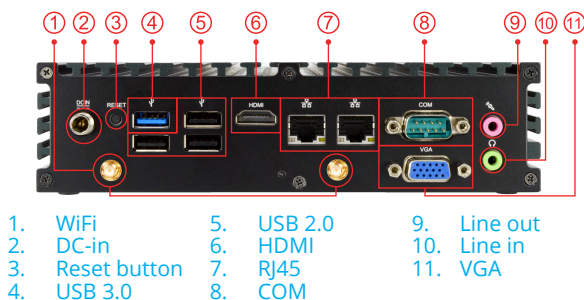

*The Specification may be changed without further notice.
www.jetwayipc.com

PICO-ITX
J10
NUC
uTX
3.5"
Mini-ITX
Desktop
Network
Expand
Proof
WT
WV
Hummer
ARM

Front IO

PICO-ITX
J10
NUC
uTX
3.5"
Mini-ITX
Desktop
Network
Expand
Proof
WT
WV
Hummer
ARM

HBJC390F541(Z)XX19B

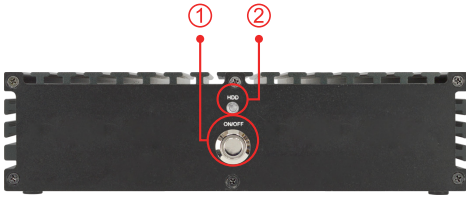

HBJC390F541(Z)XA19B

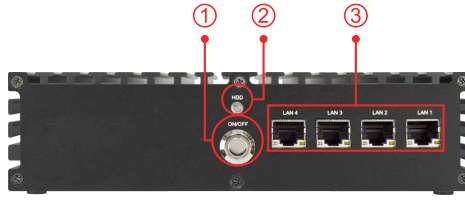

HBJC390F541(Z)CX19B

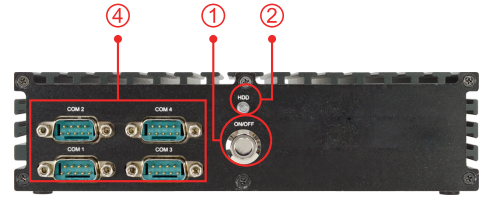

HBJC390F541(Z)XU19B

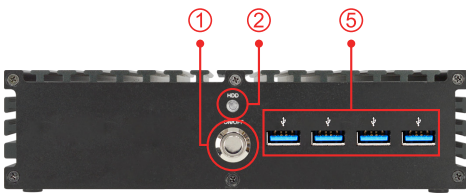

HBJC390F541(Z)XG19B

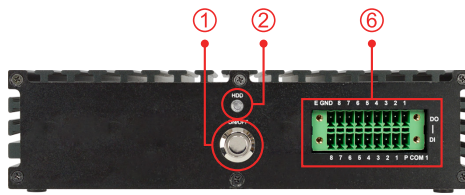

HBJC390F541(Z)CA19B

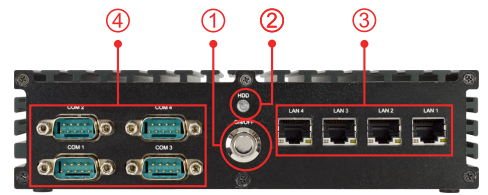

HBJC390F541(Z)CU19B

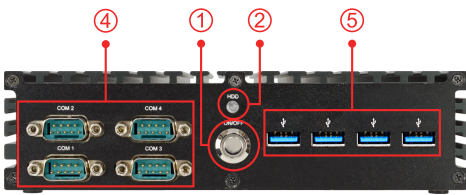

HBJC390F541(Z)CG19B

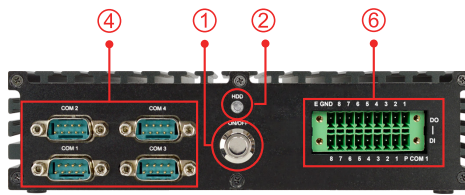

HBJC390F541(Z)AA19B

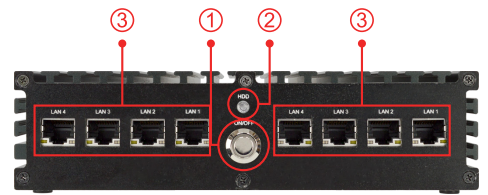

HBJC390F541(Z)CC19B

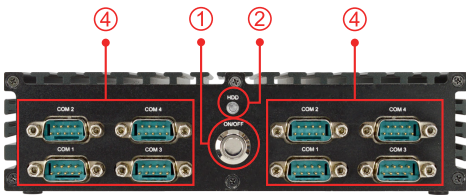

HBJC390F541(Z)AU19B

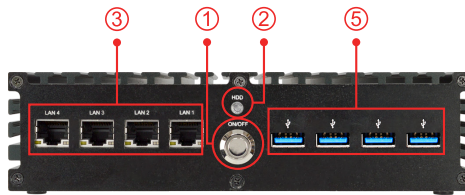

HBJC390F541(Z)AG19B

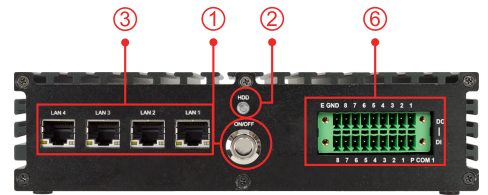

HBJC390F541(Z)GG19B

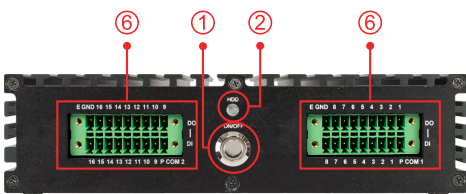

HBJC390F541(Z)GU19B

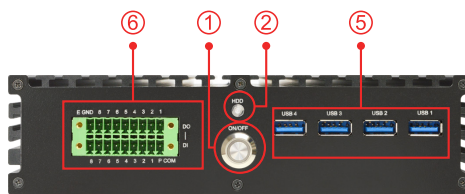

1. PW button
2. HDD LED
3. RJ45(LAN)
4. COM
5. USB 3.0
6. GPIO

*The Specification may be changed without further notice.
www.jetwayipc.com

HBJC390F841 Series



Features



- Intel® Apollo Lake J3455 Processor
- 1* DDR3L 1866MHz SO-DIMM up to 8GB
- Rear I/O: 4* USB 3.0, 2* HDMI, 2* RJ45, 1* Audio (combo), 2* COM
- Front I/O : Different interfaces such as USB
- 3.0 & GPIO & COM & LAN can be selected
- Cableless & Expandable Design
- M/B Form Factor : 100x166mm
- DC-12V_60W Adapter

Specifications

Processor	Intel® Apollo Lake J3455 Processor	Power	12V DC Power in DC-12V_60W Adapter
Chipset	SoC	Temperature	Operating : 0°C~50°C Storage: -10°C~70°C
Memory	1* DDR3L 1866MHz SO-DIMM up to 8GB	Material	Aluminum heatsink &
Ethernet	2* Intel i211AT GbE	Structure	steel plane integration structure
Display Output	2* HDMI	Dimension	165(D) x 185(W) x 48(H) mm
Storage	1 * M.2 (M-key 2280), 1* 2.5" Device		
Expansion Slot	2* Mini PCI Express (full size), 1* SIM CARD		
Front I/O	1* Power LED, 1* HDD LED, 1* Power Button (Different interfaces such as 8* USB 3.0 & 32 bit GPIO & 8* COM & 8* LAN can be selected)		
Rear I/O	4* USB 3.0, 2* HDMI, 2* RJ45, 1* Audio (combo), 2* COM, 1* DC Jack		

Rear IO

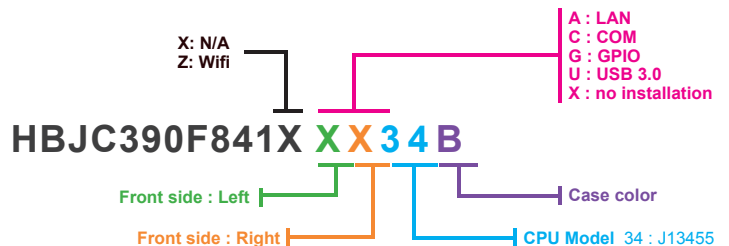
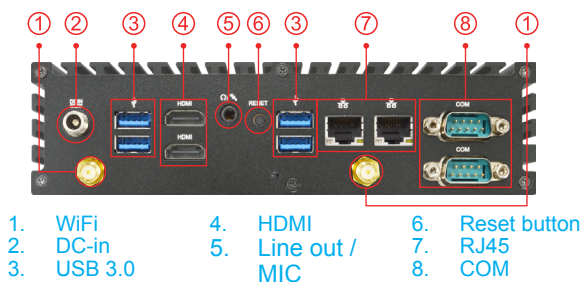

*The Specification may be changed without further notice.
www.jetwayipc.com

PICO-ITX
J10
NUC
uTX
3.5"
Mini-ITX
Desktop
Network
Expand
Proof
WT
WV
Hummer
ARM

Front IO

PICO-ITX
J10
NUC
uTX
3.5"
Mini-ITX
Desktop
Network
Expand
Proof
WT
WV
Hummer
ARM

HBJC390F841(Z)XX34B

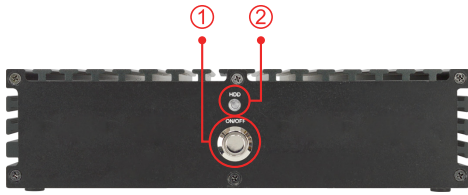

HBJC390F841(Z)XA34B

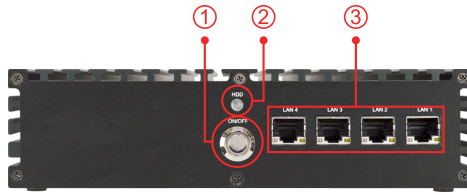

HBJC390F841(Z)CX34B

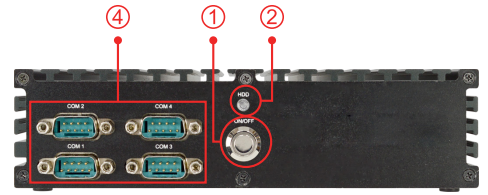

HBJC390F841(Z)XU34B

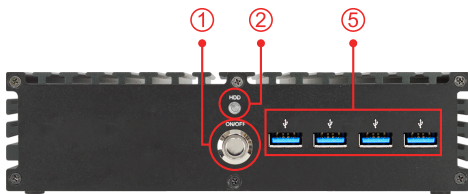

HBJC390F841(Z)XG34B

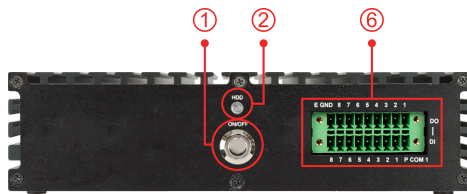

HBJC390F841(Z)CA34B

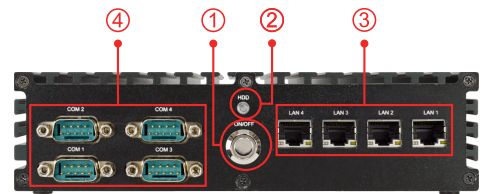

HBJC390F841(Z)CU34B

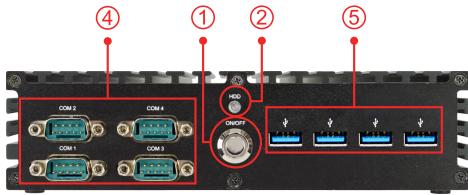

HBJC390F841(Z)CG34B

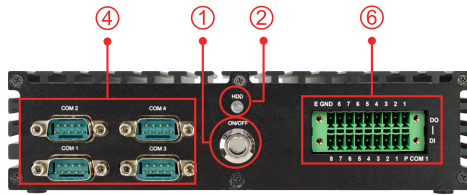

HBJC390F841(Z)AA34B

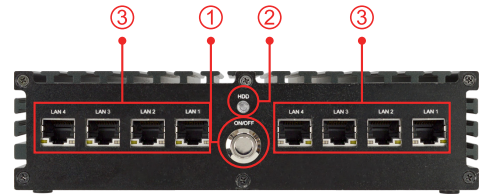

HBJC390F841(Z)CC34B

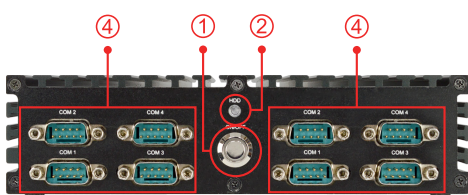

HBJC390F841(Z)AU34B

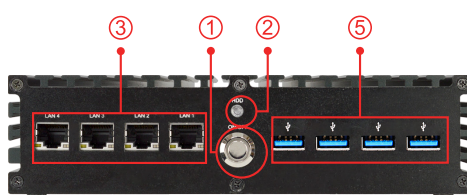

HBJC390F841(Z)AG34B

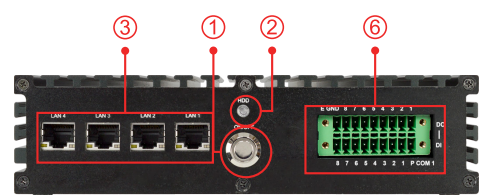

HBJC390F841(Z)GG34B

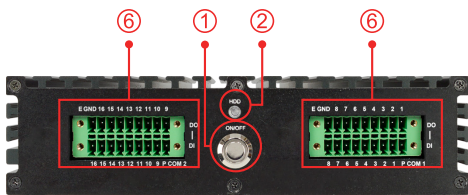

HBJC390F841(Z)GU34B

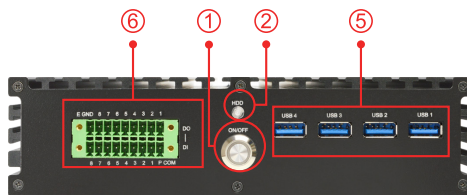

1. PW button
2. HDD LED
3. RJ45(LAN)
4. COM
5. USB 3.0
6. GPIO

*The Specification may be changed without further notice.
www.jetwayipc.com

HBFMF833-72-2C-B

Features



- Intel® Skylake/Kabylake U Processor
- 2* DDR4 2133MHz SO-DIMM up to 32GB
- **IP69K waterproof**
- 2* USB 2.0, 1* RJ45, 2* COM, 1* HDMI
- M/B Form Factor : 223x170x87.5mm
- DC-12V_60W Adapter



Front IO



1. Power SW
Power LED

Rear IO

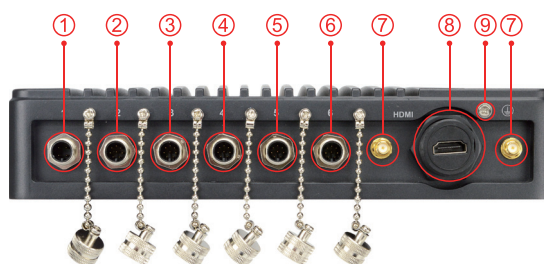

1. DC
2. LAN
3. LAN
4. USB 2.0
5. USB 3.0
6. COM 1
7. WIFI
8. HDMI
9. GND

Specifications

Processor	Intel® Skylake/Kabylake U Processor	Power	12V DC Power in DC-12V_60W Adapter
Chipset	SoC	Temperature	Operating : -20°C~60°C Storage : -10°C~70°C
Memory	2* DDR4 2133MHz SO-DIMM up to 32GB	Material	All-aluminum body, IP69K waterproof
Ethernet	1* Intel i211AT GbE	Structure	
Display Output	1* HDMI	Dimension	250(D) x 171(W) x 54(H) mm
Storage	1* 2.5" Device, 1* mSATA (full size shared)		
Expansion Slot	1* Mini PCI Express (full size)		
Front I/O	1* Power SW, 1* Power LED		
Rear I/O	2* USB 2.0, 1* RJ45, 2* COM, 1* HDMI, 2* WIFI Antenna, 1* DC-In		
Note:	Standard products out of the factory only to provide DC Cable, the rest of the USB/LAN/COM/HDMI and other wires need to be purchased additional		

*The Specification may be changed without further notice.
www.jetwayipc.com

HBFMF833-72-2L-B

Features



- Intel® Skylake/Kabylake U Processor
- 2* DDR4 2133MHz SO-DIMM up to 32GB
- IP69K waterproof
- 1* USB 3.0, 1* USB 2.0, 2* RJ45, 1* COM, 1* HDMI
- M/B Form Factor : 223x170x87.5mm
- DC-12V_60W Adapter



Front IO

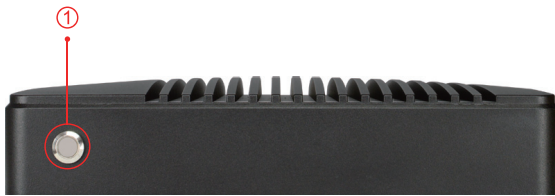

1. Power SW
Power LED

Rear IO

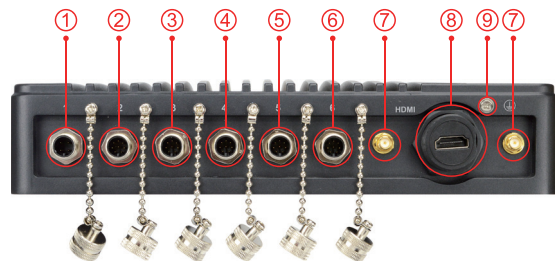

1. DC
2. LAN
3. LAN
4. USB 2.0
5. USB 3.0
6. COM 1
7. WIFI
8. HDMI
9. GND

Specifications

Processor	Intel® Skylake/Kabylake U Processor	Power	12V DC Power in DC-12V_60W Adapter
Chipset	SoC	Temperature	Operating : -20°C~60°C Storage : -10°C~70°C
Memory	2* DDR4 2133MHz SO-DIMM up to 32GB	Material	All-aluminum body, IP69K waterproof
Ethernet	1* Intel i211AT GbE, 1* Intel I219LM GbE	Structure	
Display Output	1* HDMI	Dimension	250(D) x 171(W) x 54(H) mm
Storage	1* 2.5" Device, 1* mSATA (full size shared)		
Expansion Slot	1* Mini PCI Express (full size)		
Front I/O	1* Power SW, 1* Power LED		
Rear I/O	1* USB 3.0, 1* USB 2.0, 2* RJ45, 1* COM, 1* HDMI, 2* WIFI Antenna, 1* DC-In		
Note:	Standard products out of the factory only to provide DC Cable, the rest of the USB/LAN/COM/HDMI and other wires need to be purchased additional		

*The Specification may be changed without further notice.
www.jetwayipc.com

HBJC386F951T-394B

Features



- Intel® Apollo Lake-I Series Processor
- 1* DDR3L 1866MH SO-DIMM up to 8GB
- 2* COM, 2* RS485(isolated), 1* GPIO, 1* SIM Card slot, 4* USB3.0, 1* VGA, 1* HDMI, 2* RJ45
- Operating Temperature: -20°C~70°C
- DC 9~36V input, DC-19V_90W Adapter



Front IO

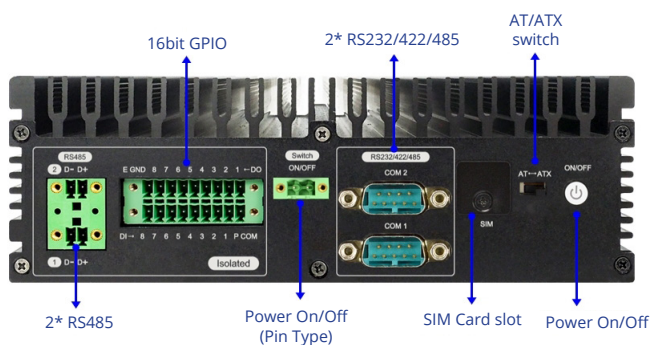

Rear IO

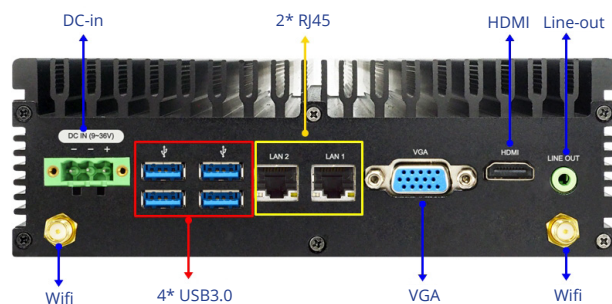

Specifications

Processor	Intel® Apollo Lake-I Series Processor (default E3940)	Power	9V~36V DC Power in (Phoenix terminal) DC-19V_90W Adapter
Chipset	SoC	Temperature	Operating : -20°C~70°C Storage : -10°C~70°C
Memory	1* DDR3L 1866MHz SO-DIMM up to 8GB	Material	All-aluminum body, produced by casting process
Ethernet	2* Intel i210 IT GbE	Structure	
Display Output	1* HDMI, 1* VGA	Dimension	142(D) x 185(W) x 60(H) mm
Storage	1* M.2 (M-key 2280), 1* 2.5" Device		
Expansion Slot	1* Mini PCI Express (full size). 1* SIM Card Slot		
Front I/O	1* Power switch, 1* Power LED, 1* ATX/AT mode Switch, 1* SIM Card slot, 2* RS232/422/485 (COM1 w/power), 1* Power switch (2 PIN out), 1* GPIO (Isolation, Output Voltage 5~20VDC), 2* RS485 (Isolation Protection)		
Rear I/O	2,500VDC 4* USB3.0, 2* RJ45, 1* VGA, 1* Line out, 1* DC-in (3 Pin Phoenix terminal)		

*The Specification may be changed without further notice.
www.jetwayipc.com

HBJC386Z9300-J19B

Features



- Intel® Bay Trail J1900 SoC Processor
- 1* DDR3L-1333MHz SO-DIMM up to 8GB
- 1 * DVI-I, 1 * HDMI, 2 * USB3.0, 4 * USB2.0, 4 * COM (COM1: RS485)
- M/B Form Factor : 3.5" (148x102mm)
- Operating Temperature: -40°C~70°C
- DC-12V_60W Adapter (Lockable type)



Front IO

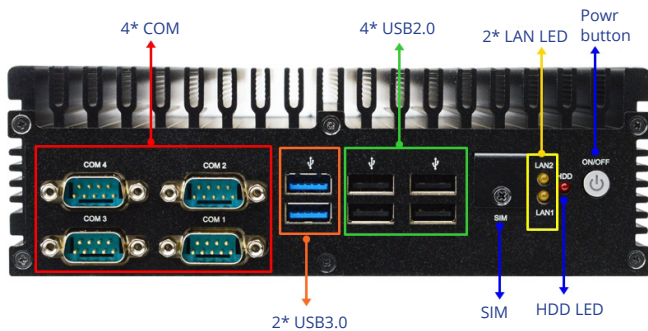

Rear IO

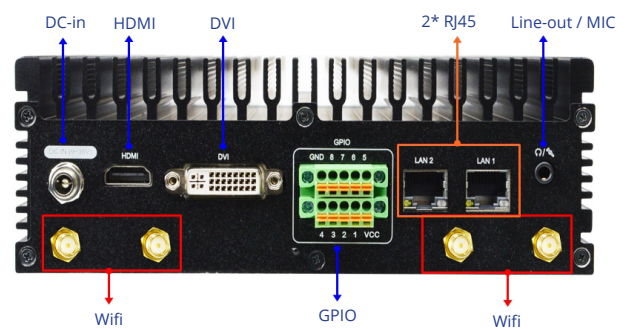

Specifications

Processor	Intel® Bay Trail J1900 SoC Processor	Power	9~24V DC Power in DC-12V_60W Adapter
Chipset	SoC	Temperature	Operating : 0°C~50°C Storage : -10°C~70°C
Memory	2* DDR3L 1600MHz SO-DIMM up to 16GB	Material	All-aluminum body, produced by casting process
Ethernet	1* Intel I211AT GbE, 1* Intel I218LM	Structure	
Display Output	2* HDMI	Dimension	142(D) x 185(W) x 60(H) mm
Storage	1* mSATA, 1* 2.5" Device		
Expansion Slot	1* Mini PCI Express (half size)		
Front I/O	1* Power LED, 1* HDD LED, 1* Power Button, 1* Reset Button, 2* USB2.0, 4* COM (Max.), 1* MIC, 1* Line out		
Rear I/O	4* USB3.0, 2* USB2.0, 2* RJ45, 2* HDMI, 1* Line out, 1* DC jack		

*The Specification may be changed without further notice.
www.jetwayipc.com

HBJC142F697-Q170B

Features



- Intel LGA 1151 Core i3/i5/i7 Processors(35W)
- 2* DDR4 2133MHz SO-DIMM up to 32GB
- 1* HDMI, 2* DP, 2* RJ45, 4* USB 3.0, 2* USB 2.0, 6* COM
- M/B Form Factor : Mini ITX (170x170mm)
- 9~24V DC in
- DC-19V_120W Adapter



Front IO

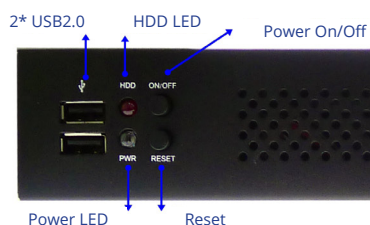

Rear IO

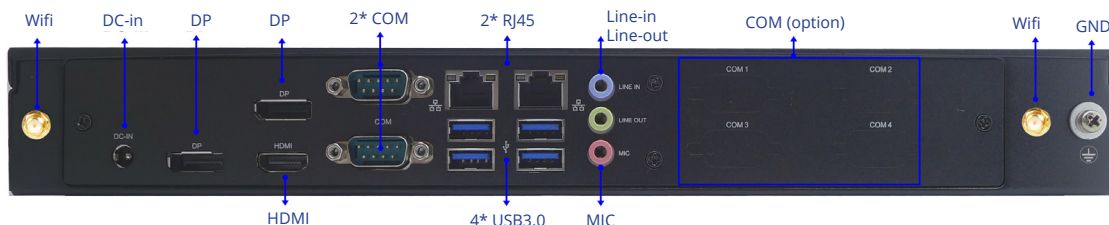

Specifications

Processor	Intel® LGA 1151 Core i3/i5/i7 Processors (35W)	Power	9~24V DC Power in DC-19V_120W Adapter
Chipset	Intel Q170 chipset	Temperature	Operating : 0°C~50°C Storage : -10°C~70°C
Memory	2* DDR4 2133MHz SO-DIMM up to 32GB	Material	Steel plane integration structure
Ethernet	1* Intel i211AT & 1* Intel i219LM GbE	Structure	
Display Output	1* HDMI, 2* DP	Dimension	192(D) x 330(W) x 44(H) mm
Storage	2* 2.5" Device		
Expansion Slot	1* Mini PCI Express (full size)		
Front I/O	1* Power LED, 1* HDD LED, 1* Power Button, 2* USB 2.0		
Rear I/O	4* USB 3.0, 2* RJ45, 1* HDMI, 2* DP, 6* COM, 1* Line in, 1* Line out, 1* MIC, 1* DC Jack		

*The Specification may be changed without further notice.
www.jetwayipc.com

HBJC310U91-2930-B

Features



- Intel BayTrail-M N2930 Processor
- 1* SO-DIMM DDR3L 1333MHz up to 8GB
- 1* COM, 2* HDMI, 1* RJ45, 1* USB 3.0, 2* USB 2.0
- M/B Form Factor : NUC (101x101mm)
- 9~24V DC in
- DC-12V_40W Adapter



Front IO

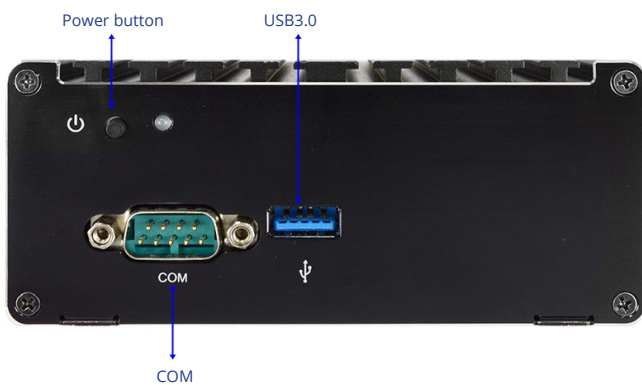

Rear IO

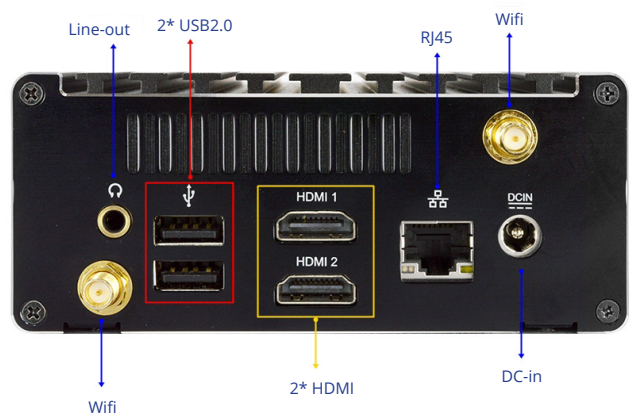

Specifications

Processor	Intel® BayTrail-M N2930 Processor	Power	9~24V DC Power in DC-12V_40W Adapter
Chipset	SoC	Temperature	Operating : 0°C~50°C Storage : -10°C~70°C
Memory	1* DDR3L 1333MHz SO-DIMM up to 8GB	Material	Aluminum heatsink &
Ethernet	1* Intel 82574L GbE	Structure	steel plane integration structure
Display Output	2* HDMI	Dimension	110(D) x 116(W) x 49(H) mm
Storage	1* mSATA (full size)		
Expansion Slot	1* Mini PCI Express (half size)		
Front I/O	1* USB 3.0, 1* COM 1* Power LED, 1* Power Button		
Rear I/O	2* USB 2.0, 2* HDMI, 1* Line out, 1* RJ45, 1* DC Jack		

*The Specification may be changed without further notice.
www.jetwayipc.com

HBJC311U93-2930-B

Features



- Intel Bay Trail-M N2930 Processor
- 1* DDR3L 1333MHz SO-DIMM up to 8GB
- 1* COM, 2* HDMI, 2* RJ45, 1* USB 3.0, 3* USB 2.0
- M/B Form Factor : NUC (101x101mm)
- 9~24V DC in
- DC-12V_40W Adapter



Front IO

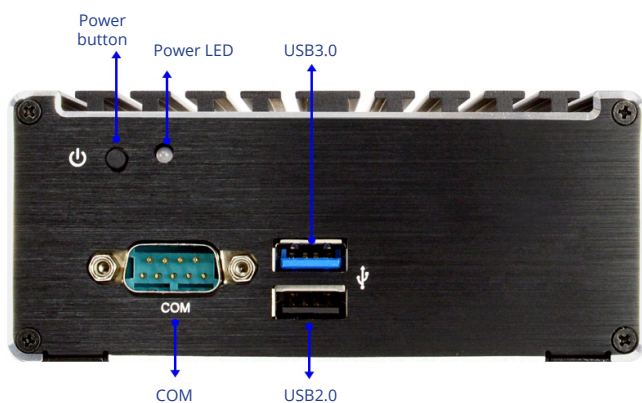

Rear IO

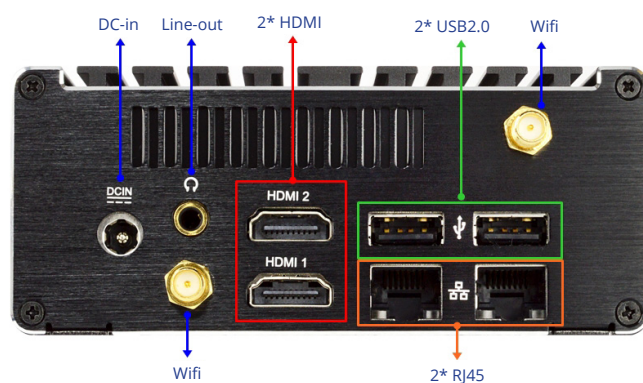

Specifications

Processor	Intel® Bay Trail-M N2930 Processor	Power	9~24V DC Power in DC-12V_40W Adapter
Chipset	SoC	Temperature	Operating : 0°C~50°C Storage : -10°C~70°C
Memory	1* DDR3L 1333MHz SO-DIMM up to 8GB	Material	Aluminum heatsink &
Ethernet	2* Intel 82583V GbE	Structure	steel plane integration structure
Display Output	2* HDMI	Dimension	110(D) x 116(W) x 49(H) mm
Storage	1* mSATA (full size)		
Expansion Slot	1* Mini PCI Express (half size)		
Front I/O	1* USB 3.0, 1* USB 2.0, 1* COM 1* Power LED, 1* Power Button		
Rear I/O	2* USB 2.0, 2* HDMI, 1* Line out, 2* RJ45, 1* DC Jack		

*The Specification may be changed without further notice.
www.jetwayipc.com

HBJC320U93-2930-B

Features



- Intel Bay Trail-M N2930 Processor
- 1* DDR3L 1333MHz SO-DIMM up to 8GB
- 1* COM, 2* HDMI, 2* RJ45, 1* USB 3.0, 3* USB 2.0, 1* 2.5" Device
- M/B Form Factor : NUC (101x101mm)
- 9~24V DC in
- DC-12V_40W Adapter



Front IO

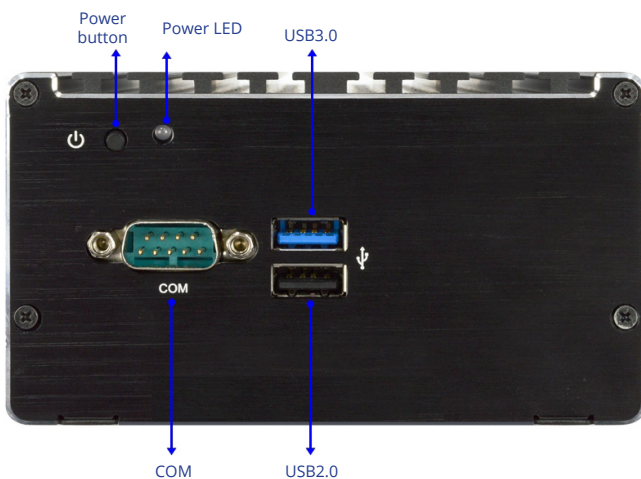

Rear IO

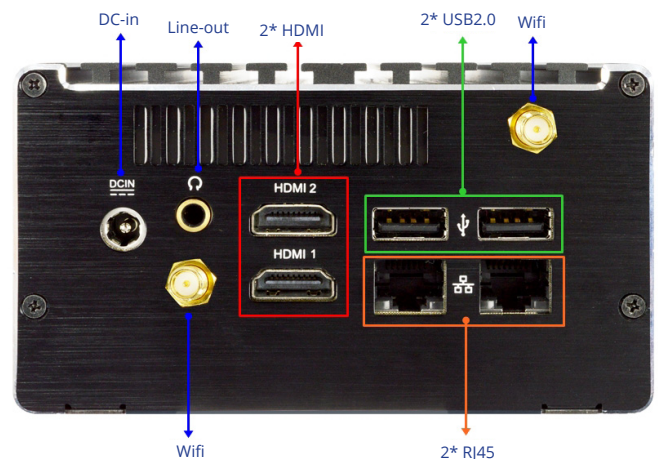

Specifications

Processor	Intel® Bay Trail-M N2930 Processor	Power	9~24V DC Power in DC-12V_40W Adapter
Chipset	SoC	Temperature	Operating : 0°C~50°C Storage : -10°C~70°C
Memory	1* DDR3L 1333MHz SO-DIMM up to 8GB	Material	Aluminum heatsink &
Ethernet	2* Intel 82583V GbE	Structure	steel plane integration structure
Display Output	2* HDMI	Dimension	110(D) x 116(W) x 65(H) mm
Storage	1* mSATA (full size), 1* 2.5" Device		
Expansion Slot	1* Mini PCI Express (half size)		
Front I/O	1* USB 3.0, 1* USB 2.0, 1* COM 1* Power LED, 1* Power Button		
Rear I/O	2* USB 2.0, 2* HDMI, 1* Line out, 2* RJ45, 1* DC jack		

*The Specification may be changed without further notice.
www.jetwayipc.com

HBJC330U95-8265

Features



- Intel® Whiskey Lake i5-8265U Processor
- 2* DDR4 2400MHz up to 32GB
- 1* Intel® I219LM GbE + 1* I211AT GbE
- 1* DP1.4, 1* HDMI2.0, 1* HDMI1.4
- 1* M.2 (M-Key, SATA Interface), 1* M.2 (E-Key, Support CNVi)
- 4* USB3.2, 1* RS232/RS422/485
- M/B Form Factor : NUC (101x101mm)
- 12~24V DC-in



Front IO

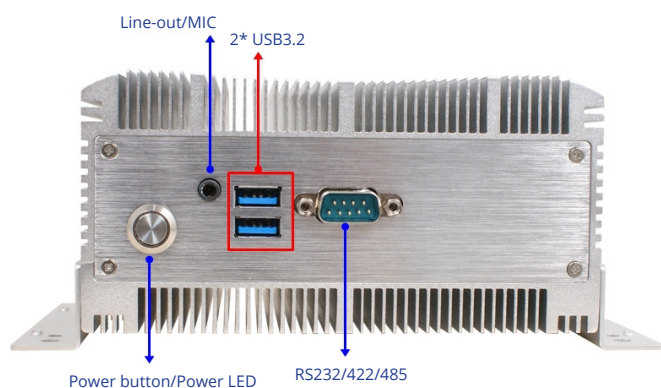

Rear IO

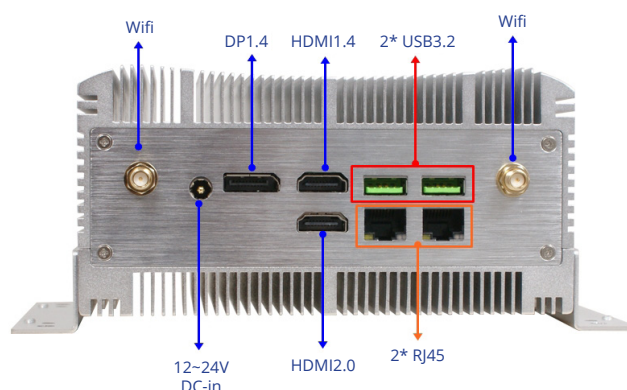

Specifications

Processor	Intel® Whiskey Lake 8265U Processor	Power	12~24V DC Power in DC-12V_60W Adapter
Chipset	SoC	Temperature	Operating : -10°C~50°C Storage : -20°C~60°C
Memory	2* DDR4 2400MHz SO-DIMM up to 32GB	Material	Aluminum heatsink &
Ethernet	2* Intel GbE (I219LM + I211AT)	Structure	steel plane integration structure
Display Output	1* DP1.4, 1* HDMI2.0, 1* HDMI1.4	Dimension	106(D) x 150(W) x 75(H) mm
Storage	1* M.2 (M-Key 2242, support SATA)		
Expansion Slot	1* M.2 E Key Socket for CNVi or PCI-E/USB WIFI/BT		
Front I/O	2* USB3.2, 1* RS232/422/485, 1* power Button, 1* Line-out/MIC		
Rear I/O	2* USB3.2, 1* DP, 2* HDMI, 2* RJ45, 1* DC jack		

*The Specification may be changed without further notice.
www.jetwayipc.com

HBJC330U95-8265

Features



- Intel® Whiskey Lake i5-8265U Processor
- 1* DDR4 2400MHz up to 32GB
- 1* Intel® I219LM GbE + 1* I211AT GbE
- 1* DP1.4, 1* HDMI2.0, 1* HDMI1.4
- 1* M.2 (M-Key, SATA Interface), 1* M.2 (E-Key, Support CNVi)
- 4* USB3.2, 1* RS232/RS422/485
- M/B Form Factor : NUC (101x101mm)
- DC-12~24V Adapter



Front IO

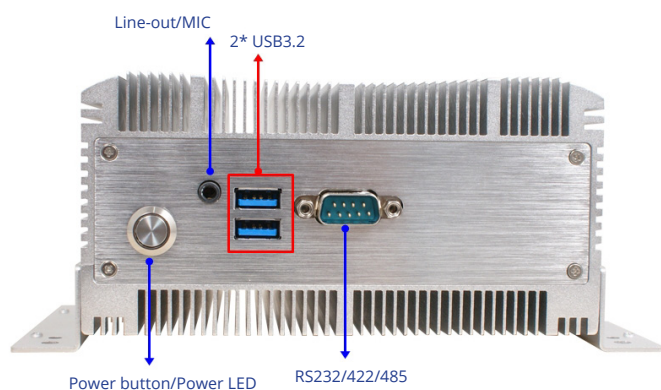

Rear IO

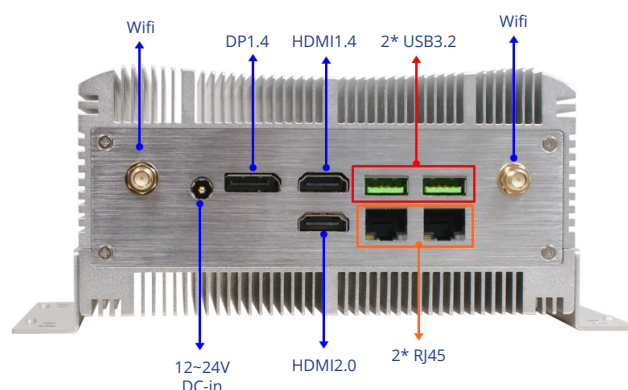

Specifications

Processor	Intel® Whiskey Lake 8265U Processor	Power	12~24V DC Power in DC-12V_60W Adapter
Chipset	SoC	Temperature	Operating : -10°C~50°C Storage : -20°C~760°C
Memory	2* DDR4 2400MHz SO-DIMM up to 32GB	Material	Aluminum heatsink &
Ethernet	2* Intel GbE (I219LM + I211AT)	Structure	steel plane integration structure
Display Output	1* DP1.4, 1* HDMI2.0, 1* HDMI1.4	Dimension	106(D) x 150(W) x 75(H) mm
Storage	1* M.2 (M-Key 2242, support SATA)		
Expansion Slot	1* M.2 E Key Socket for CNVi or PCI-E/USB WIFI/BT		
Front I/O	2* USB3.2, 1* RS232/422/485, 1* Power Button, 1* Line-out/MIC		
Rear I/O	2* USB3.2, 1* DP, 2* HDMI, 2* RJ45, 1* DC jack		

*The Specification may be changed without further notice.
www.jetwayipc.com

HBJC377F531M-316B

Features



- Intel® Braswell N3160 SoC processor
- 1* DDR3L 1600MHz SODIMM up to 8GB
- 1* HDMI, 1* DP, 2* RJ45, 4* USB3.0, 2* USB2.0, 5* COM (Max.), 1* COM (RJ45 Type)
- M/B Form Factor : 3.5" (148x102mm)
- 9~36V DC input
- DC-12V_60W Adapter



Front IO

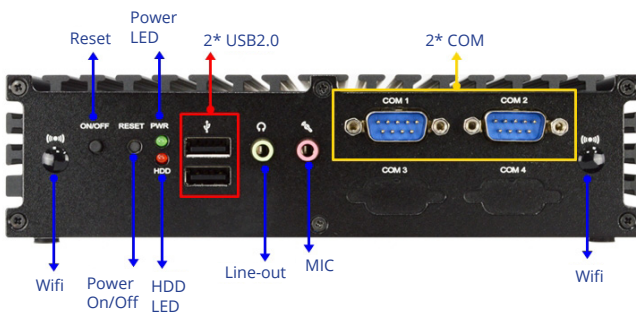

Rear IO

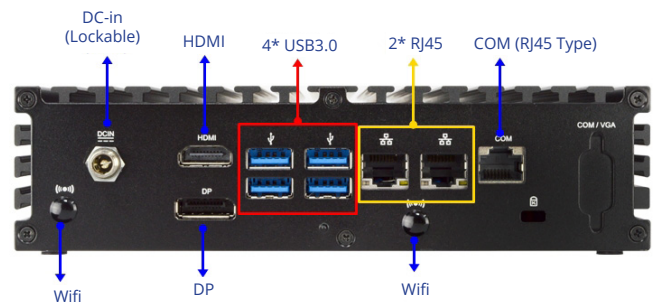

Specifications

Processor	Intel® Braswell N3160 SoC Processor	Power	9~36V DC Power in DC-12V_60W Adapter
Chipset	SoC	Temperature	Operating : 0°C~50°C Storage : -10°C~70°C
Memory	1* DDR3L 1600MHz SO-DIMM up to 8GB	Material	Aluminum heatsink &
Ethernet	2* Intel i211AT GbE	Structure	steel plane integration structure
Display Output	1* HDMI, 1* DP	Dimension	142(D) x 185(W) x 48(H) mm
Storage	1* M.2 (M key-2242), 1* 2.5" Device		
Expansion Slot	1* Mini PCI Express (half size)		
Front I/O	2* USB 2.0, 2* COM (COM1 supports RS232/422/485, setting by BIOS), 1* Reset, button, 1* Power button, 1* Power LED, 1* HDD LED, 1* Line-out, 1* MIC		
Rear I/O	1* DC jack, 1* HDMI, 1* DP, 2* RJ45, 4* USB3.0, 1* COM (RJ45 Type)		

*The Specification may be changed without further notice.
www.jetwayipc.com

HBJC382F632 Series

Features



- Intel® Skylake/Kabylake U-Series Processor
- 2* DDR4 2133MHz SO-DIMM up to 32GB
- 1* HDMI, 1* DP, 2* RJ45, 4* USB 3.0, 4* USB 2.0, 4* COM (Max.)
- M/B Form Factor : 3.5" (148x102mm)
- 9~24V DC input
- DC-12V_60W Adapter



Front IO



Rear IO

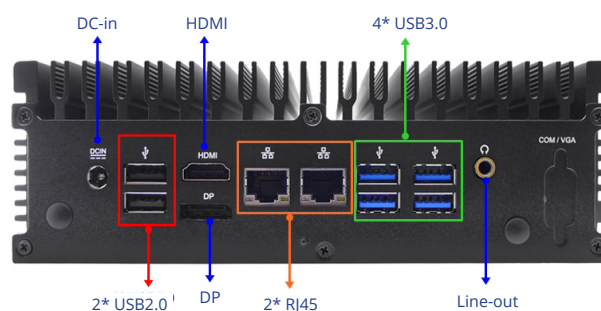

Specifications

Processor	Intel® Skylake/Kabylake U-Series Processor	Power	9~24V DC Power in DC-12V_60W Adapter
Chipset	SoC	Temperature	Operating : 0°C~50°C Storage : -10°C~70°C
Memory	2* DDR4 2133MHz SO-DIMM up to 32GB	Material	Aluminum heatsink &
Ethernet	1* Intel i211AT GbE, 1* Intel i219LM GbE	Structure	steel plane integration structure
Display Output	1* HDMI, 1* DP	Dimension	142(D) x 185(W) x 60(H) mm
Storage	1* mSATA (full size shared), 1* 2.5" Device		
Expansion Slot	2* Mini PCI Express (full & half size)		
Front I/O	1* Power LED, 1* HDD LED, 1* Power Button, 1* Reset button, 2* USB 2.0, 4* COM (Max.), 1* MIC, 1* Line out		
Rear I/O	4* USB 3.0, 2* USB 2.0, 2* RJ45, 1* HDMI, 1* DP, 1* Line out, 1* DC jack		

*The Specification may be changed without further notice.
www.jetwayipc.com

HBJC420U91-2930-B

Features



- Intel® BayTrail-M N2930 Processor
- 1* DDR3L 1333MHz SO-DIMM up to 8GB
- 1* COM, 2* HDMI, 1* RJ45, 1* USB 3.0, 2* USB 2.0
- M/B Form Factor : NUC (101x101mm)
- 9~24V DC input
- DC-12V_40W Adapter



Front IO

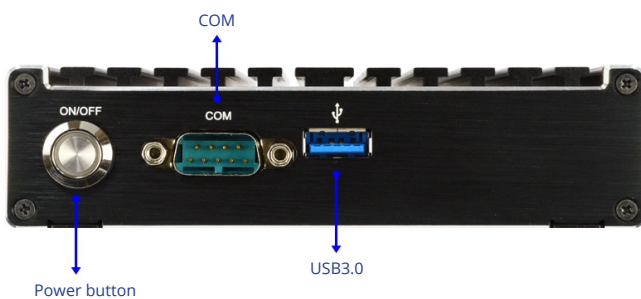

Rear IO

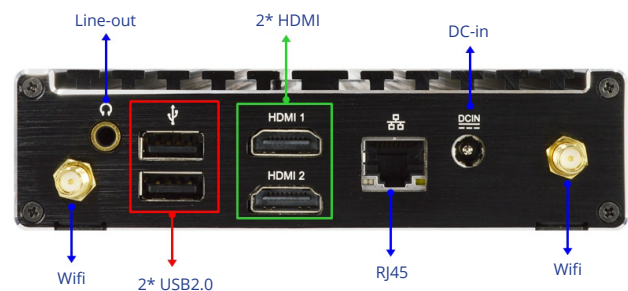

Specifications

Processor	Intel® Bay Trail-M N2930 Processor	Power	9~24V DC Power in DC-12V_40W Adapter
Chipset	SoC	Temperature	Operating : 0°C~50°C Storage : -10°C~70°C
Memory	1* SDDR3L 1333MHz SO-DIMM up to 8GB	Material	Aluminum heatsink &
Ethernet	1* Intel 82574L GbE	Structure	steel plane integration structure
Display Output	2* HDMI	Dimension	109.4(D) x 129(W) x 34(H) mm
Storage	1* mSATA (full size)		
Expansion Slot	1* Mini PCI Express (half size)		
Front I/O	1* USB 3.0, 1* COM 1* Power LED, 1* Power Button		
Rear I/O	2* USB 2.0, 2* HDMI, 1* Line out, 1* RJ45, 1* DC Jack		

*The Specification may be changed without further notice.
www.jetwayipc.com

HBJC501F9Q-Q87-B

Features



- Intel® LGA 1150 Core i3/i5/i7 Processors (35W)
- 2* DDR3 1600MHz SO-DIMM up to 16GB
- 1* HDMI, 1* DVI-I, 2* RJ45, 4* USB 3.0, 2* USB 2.0, 5* COM
- M/B Form Factor : Mini ITX (170x170mm)
- 9~24V DC input
- DC-19V_120W Adapter



Front IO



Rear IO

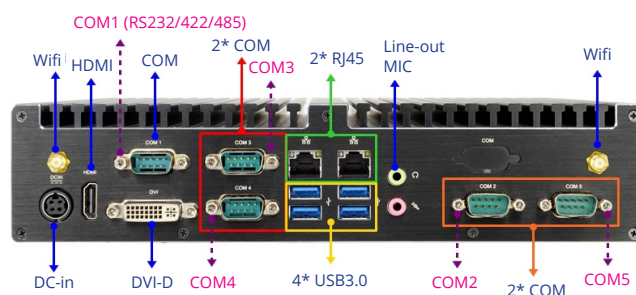

Specifications

Processor	Intel® LGA 1150 Core i3/i5/i7 Processors (35W)	Power	9~24V DC Power in DC-19V_120W Adapter
Chipset	Intel® Q87 Chipset	Temperature	Operating : 0°C~50°C Storage : -10°C~70°C
Memory	2* DDR3 1600MHz SO-DIMM up to 16GB	Material	Aluminum heatsink &
Ethernet	1* Intel i211AT & 1* Intel i217LM GbE	Structure	steel plane integration structure
Display Output	1* HDMI, 1* DVI-I	Dimension	199.4(D) x 264(W) x 58(H)mm
Storage	1* mSATA (full size), 1* 2.5" Device		
Expansion Slot	1* Mini PCI Express (half size)		
Front I/O	1* Power LED, 1* HDD LED, 1* Power Button, 2* USB 2.0		
Rear I/O	4* USB 3.0, 2* RJ45, 1* DVI-I, 1* HDMI, 5* COM, 1* Line out, 1* MIC, 1* DC Jack		

*The Specification may be changed without further notice.
www.jetwayipc.com

HBJC501F9QU-Q87-B

Features



- Intel® LGA 1150 Core i3/i5/i7 Processors (35W)
- 2* DDR3 1600MHz SO-DIMM up to 16GB
- 1* HDMI, 1* DVI-D, 1* VGA, 2* RJ45, 4* USB 3.0, 2* USB 2.0, 4* COM
- M/B Form Factor : Mini ITX (170x170mm)
- 9~24V DC input
- DC-19V_120W Adapter



Front IO



Rear IO

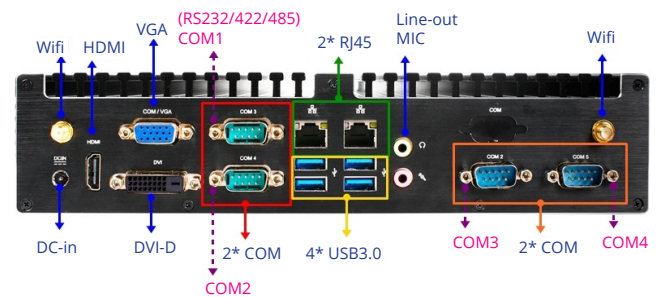

Specifications

Processor	Intel® LGA 1150 Core i3/i5/i7 Processors (35W)	Power	9~24V DC Power in DC-19V_120W Adapter
Chipset	Intel® Q87 Chipset	Temperature	Operating : 0°C~50°C Storage : -10°C~70°C
Memory	2* DDR3 1600MHz SO-DIMM up to 16GB	Material	Aluminum heatsink &
Ethernet	1* Intel i211AT & 1* Intel i217LM GbE	Structure	steel plane integration structure
Display Output	1* HDMI, 1* DVI-D, 1* VGA	Dimension	199.4(D) x 264(W) x 58(H)mm
Storage	1* mSATA (full size), 1* 2.5" Device		
Expansion Slot	1* Mini PCI Express (half size)		
Front I/O	1* Power LED, 1* HDD LED, 1* Power Button, 2* USB 2.0		
Rear I/O	4* USB 3.0, 2* RJ45, 1* VGA, 1* DVI-D, 1* HDMI, 4* COM, 1* Line out, 1* MIC, 1* DC Jack		

*The Specification may be changed without further notice.
www.jetwayipc.com

HBJC501F697-Q17-B

Features



- Intel LGA 1151 Core i3/i5/i7 Processors (35W)
- 2* DDR4 2133MHz SO-DIMM up to 32GB
- 1* HDMI, 2* DP, 2* RJ45, 4* USB 3.0, 2* USB 2.0, 6* COM
- M/B Form Factor : Mini ITX (170x170mm)
- 9~24V DC input
- DC-19V_120W Adapter



Front IO



Rear IO

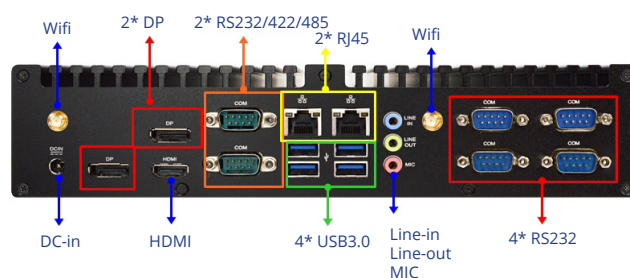

Specifications

Processor	Intel® LGA 1151 Core i3/i5/i7 Processors (35W)	Power	9~24V DC Power in DC-19V_120W Adapter
Chipset	Intel® Q170 chipset	Temperature	Operating : 0°C~50°C Storage : -10°C~70°C
Memory	2* DDR4 2133MHz SO-DIMM up to 32GB	Material	Aluminum heatsink &
Ethernet	1* Intel i211AT & 1* Intel i219LM GbE	Structure	steel plane integration structure
Display Output	1* HDMI, 2* DP	Dimension	199.4(D) x 264(W) x 58(H)mm
Storage	1* 2.5" Device		
Expansion Slot	1* Mini PCI Express (full size)		
Front I/O	1* Power LED, 1* HDD LED, 1* Power Button, 2* USB 2.0		
Rear I/O	4* USB 3.0, 2* RJ45, 1* HDMI, 2* DP, 6* COM, 1* Line in, 1* Line out, 1* MIC, 1* DC Jack		

*The Specification may be changed without further notice.
www.jetwayipc.com

HBJC501F797-Q370-B

Features



- Intel® LGA1151 Coffee Lake Processor (35W)
- 2* DDR4 2666MHz SO-DIMM up to 32GB
- 4* USB 3.1, 2* USB 2.0, 1* HDMI, 2* DP, 2* RJ45, 2* COM
- M/B Form Factor : Mini ITX (170x170mm)
- 9~36V DC input
- DC-19V_120W Adapter



Front IO



Rear IO

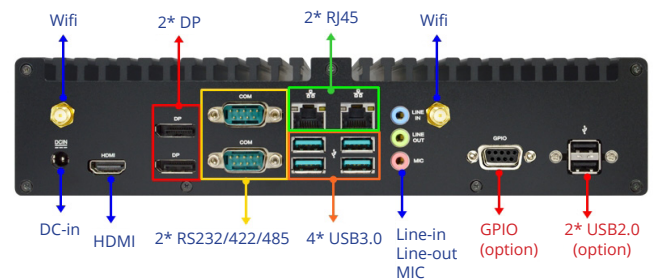

Specifications

Processor	Intel® LGA1151 Coffee Lake Processor (35W)	Power	9~36V DC Power in DC-19V_120W Adapter
Chipset	Intel® Q370 chipset	Temperature	Operating : -20°C~50°C Storage : -10°C~70°C
Memory	2* DDR4 2666MHz SO-DIMM up to 32GB	Material	Aluminum heatsink &
Ethernet	1* Intel i211AT & 1* Intel i219LM GbE	Structure	steel plane integration structure
Display Output	1* HDMI, 2* DP	Dimension	199.4(D) x 264(W) x 58(H)mm
Storage	1* M.2-2280 (M-KEY), 1* 2.5" Device		
Expansion Slot	1* M.2-2230 (E-KEY), 1* SIM Card		
Front I/O	1* Power LED, 1* HDD LED, 1* Power Button, 2* USB 2.0		
Rear I/O	4* USB 3.1, 1* HDMI, 2* DP, 2* RJ45, 1* Line in, 1* Line out, 1* MIC, 2* COM, 1* DC Jack		

*The Specification may be changed without further notice.
www.jetwayipc.com

HBJC501C8H-H310

Features



- Intel® LGA1151 Socket Core I3,I5,I7 Pentium Processor
- 2* DDR4 2133MHz up to 32GB
- 4* USB3.0, 4* RS232 (COM1/2 Support 5V/12V TTL), 1* M.2, 2* RJ45
- M/B Form Factor : Mini ITX (170x170mm)
- 12~24V DC input
- DC 19V_120W Adapter



Front IO

Rear IO

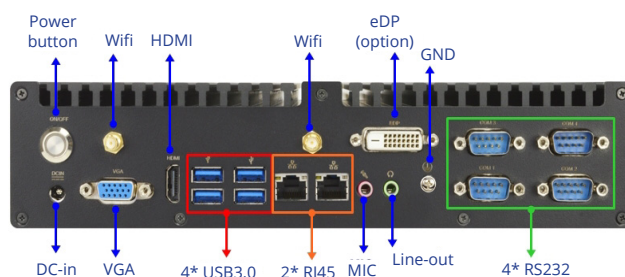

Specifications

Processor	Intel® LGA1151 Socket Core I3,I5,I7 Pentium Processor	Power	12~24V DC Power in DC 19V_120W Adapter
Chipset	Intel® Coffee Lake-S H310 chipset	Temperature	Operating : -10°C~50°C Storage : -20°C~60°C
Memory	2 * DDR4 2133MHz SO-DIMM up to 32GB	Material	Aluminum heatsink &
Ethernet	1* Intel I219-V, 1* I211AT GbE	Structure	steel plane integration structure
Display Output	1* HDMI, 1* VGA, 1* eDP (Option)	Dimension	199.4(D) x 264(W) x 58(H)mm
Storage	1* M.2-2242, 1* 2.5" Device		
Expansion Slot	1* M.2 M Key Socket for SSD, 1* M.2 E Key Socket for CNVi or PCI-E/USB WIFI/BT		
Front I/O	N/A		
Rear I/O	4* USB 3.0, 1* HDMI, 1* VGA, 1* eDP (Option), 2* RJ45, 4* RS232 1* Line-out & MIC, 1* DC Jack, 1* Power Button		

*The Specification may be changed without further notice.
www.jetwayipc.com

HBJC512F532-2930-B

Features



- Intel® Bay Trail-M 2930 SoC Processor
- 1* DDR3L 1333MHz SDRAM up to 4GB
- 2* GbE, 4* 100M PoE LAN
- 1* USB3.0, 5* USB2.0, 1* DVI-D
- M/B Form Factor : 3.5" (148x102mm)
- Support Wide Voltage 90~240 AC in



Front IO

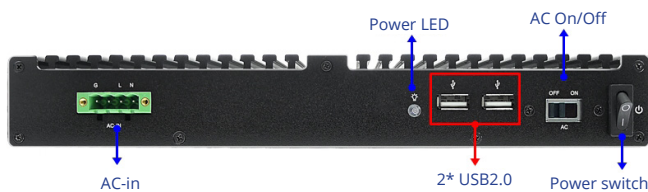

Rear IO

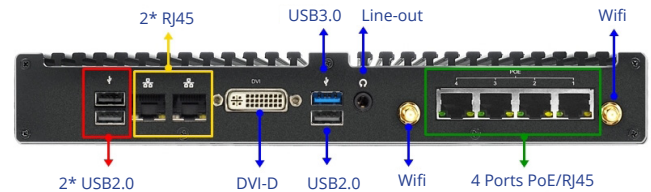

Specifications

Processor	Intel® Bay Trail-M 2930 SoC Processor	Power	AC 90~240V input 150W AC-DC OP Power inside
Chipset	Intel® N2930 chipset	Temperature	Operating : 0°C~50°C Storage : -10°C~70°C
Memory	1* DDR3L 1333MHz SDRAM up to 4GB	Material	Aluminum heatsink &
Ethernet	4* 100M PoE LAN (DC52.5V-1.94A-102W)	Structure	steel plane integration structure
Display Output	1* DVI-D	Dimension	199.4(D) x 264(W) x 38(H)mm
Storage	1* 2.5" Device		
Expansion Slot	1* Mini PCI Express (full Size)		
Front I/O	1* 4 PIN AC in, 1* AC ON-OFF, 1* Power LED, 1* Power switch, 2* USB 2.0		
Rear I/O	1* USB3.0, 3* USB2.0, 1* DVI-D, 2* GbE, 1* Audio (Line out), 4* PoE		

*The Specification may be changed without further notice.
www.jetwayipc.com

HBJC512F3EG-4300B

Features



- Intel® Haswell I5 4300U Processor
- 2* DDR3L 1333/1600MHz SO-DIMM
- 2* GbE, 4* 1000M POE LAN
- 4* USB3.0, 2* USB2.0, 2* HDMI
- M/B Form Factor : 3.5" (148x102mm)
- Support Wide Voltage 90~240 AC-in



Front IO

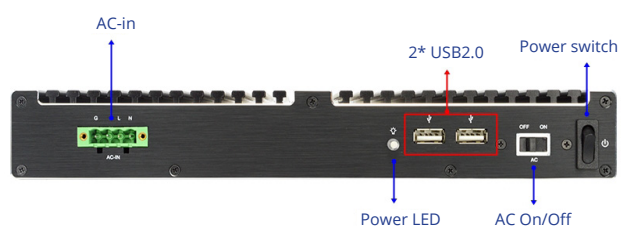

Rear IO

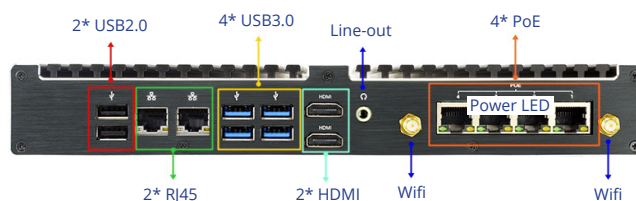

Specifications

Processor	Intel® Haswell I5 4300U Processor	Power	AC 90~240V input 150W AC to DC OP Power inside
Chipset	Intel® 4300U chipset	Temperature	Operating : -10°C~50°C Storage : -10°C~70°C
Memory	2* DDR3L 1333/1600MHz SO-DIMM	Material	Aluminum heatsink &
Ethernet	4* 1000M POE LAN	Structure	steel plane integration structure
Display Output	2* HDMI	Dimension	199.4(D) x 264(W) x 38(H)mm
Storage	1* 2.5" Device		
Expansion Slot	1* Mini PCI Express (full Size)		
Front I/O	1* 4 PIN AC Input, 1* AC ON-OFF, 1* Power LED, 1* Power switch, 2* USB2.0		
Rear I/O	4* USB3.0, 2* USB2.0, 2* HDMI, 2* GbE, 4* PoE, 1* Audio		

*The Specification may be changed without further notice.
www.jetwayipc.com

HBJC801C7B-7200

Features



- Intel® Kaby Lake i5-7200U Processor
- 1* DDR4 2133MHz SO-DIMM up to 16GB
- 2* Intel® GbE, 2* USB3.0, 6* USB2.0
- 1* eDP, 1* HDMI
- M/B Form Factor : 120x177mm
- Support Wide Voltage 9~24V DC-in
- DC 12V_60W Adapter



Front IO

Rear IO

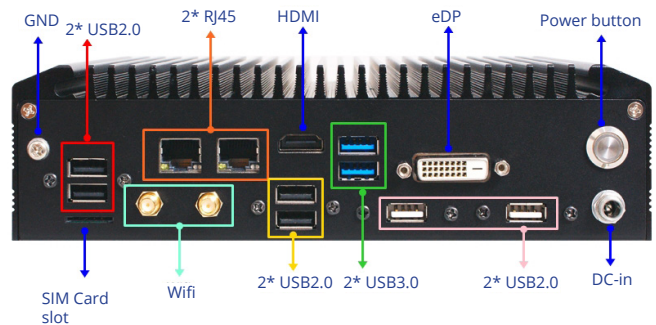

Specifications

Processor	Intel® Kaby Lake i5-7200U Processor	Power	9~24V DC input DC 12V_60W Adapter
Chipset	Intel® 7200U chipset	Temperature	Operating : -10°C~50°C Storage : -20°C~60°C
Memory	1* DDR4 2133MHz SO-DIMM up to 16GB	Material	Aluminum heatsink &
Ethernet	1* Intel I219LM, 1* i211AT GbE	Structure	steel plane integration structure
Display Output	1* eDP, 1* HDMI	Dimension	135(D) x 215(W) x 60(H)mm
Storage	1* mSATA, 1* 2.5" Device		
Expansion Slot	2* Mini PCI Express (full Size), 2* SIM Card slot		
Front I/O	N/A		
Rear I/O	2* USB 3.0, 6* USB2.0, 1* HDMI, 1* eDP, 2* RJ45, 1* DC Jack (Lockable), 1* Power Button		

*The Specification may be changed without further notice.
www.jetwayipc.com

HBJC909C9A-H310

Features



- Intel® LGA1151 Socket Processor (Max 35W) with Coffee Lake-S H310 Chip
- 2* DDR4 2133MHz up to 32GB
- MXM Type A/B VGA Card (Type A or B), 1* M.2 E key Support CNVi, 1* M.2 (B-key)
- 2* RS232 (COM1/2 : 5V/12V TTL), 4* USB3.1, 4* USB2.0, 1* GbE, 4* HDMI, 2* DP, 1* eDP (By MXM)
- 12~36V DC-in



Front IO

Rear IO

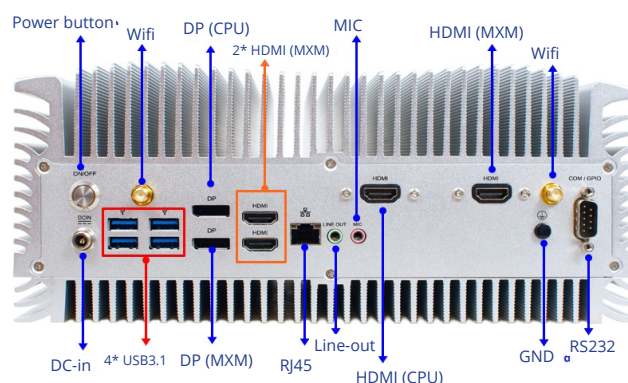

Specifications

Processor	Intel® LGA1151 Socket Processor	Power	12~36V DC input DC 19V_180W Adapter
Chipset	Intel® Coffee Lake-S H310 Chip	Temperature	Operating : -10°C~50°C Storage : -20°C~60°C
Memory	2* DDR42133MHz up to 32GB	Material	Aluminum heatsink &
Ethernet	1* Intel® I219LM GbE	Structure	steel plane integration structure
Display Output	2* DP, 4* HDMI	Dimension	244(D) x 279.8(W) x 115.9(H)mm
Storage	1* M.2 M-Key (2280, Support NVMe), 1* 2.5" Device		
Expansion Slot	1* M.2 (2230), 1* M.2 (3042)		
Front I/O	N/A		
Rear I/O	4* USB3.1, 2* DP (Up: DP By CPU, Bottom: DP By MXM VGA Card), 4* HDMI (2* EXT HDMI By MXM, INT HDMI2 BY MXM, INT HDMI1 By CPU), 1* RJ45, 1* RS232, 1* Line-out, MIC, 1* DC Jack, 1* Power button		

*The Specification may be changed without further notice.
www.jetwayipc.com

HBFACT95-90B

Features



- Intel® Apollo Lake-I SoC Processor
- 1* DDR3L 1866MHz SO-DIMM up to 8GB
- 4* USB3.1, 2* HDMI, 2* RJ45, 1* MIC/Line-out Combo, 1* COM (RJ45 type)
- Operating Temperature: -40 ~ 70° C
- M/B Form Factor : uTX (117x112mm)
- DC-12V_60W Adapter



Front IO

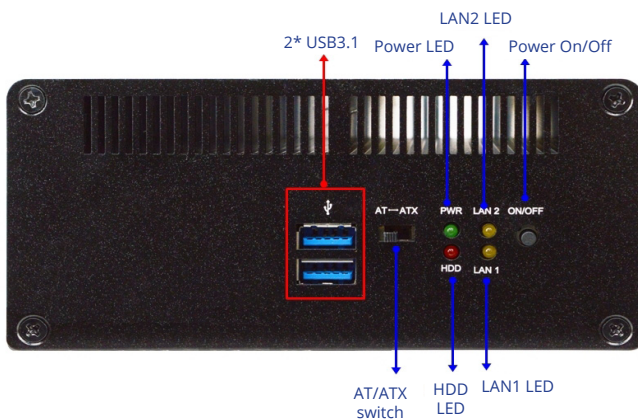

Rear IO

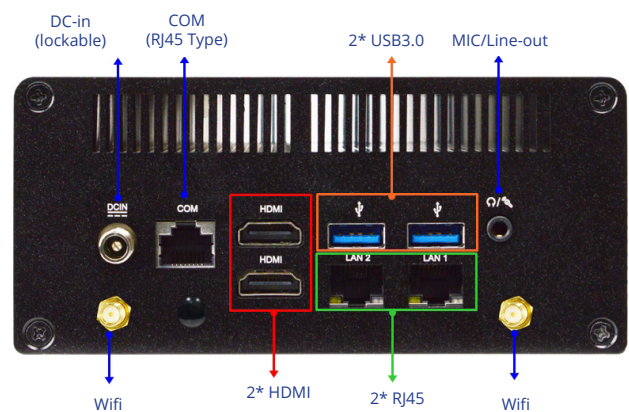

Specifications

Processor	Intel® Apollo Lake-I E3940 SoC Processor	Power	90~240V AC input DC 12V_60W Adapter
Chipset	Intel® E3940 SoC chipset	Temperature	Operating : -40°C~70°C Storage : -40°C~85°C
Memory	1* DDR3L 1866MHz SO-DIMM up to 8GB	Material	Aluminum heatsink &
Ethernet	2* Intel® i210AT GbE	Structure	steel plane integration structure
Display Output	2* HDMI	Dimension	116.9(D) x 144(W) x 65(H)mm
Storage	1* M.2 M-key (2242) Support SATA interface		
Expansion Slot	1* M.2 (2230), 1* M.2 (3042)		
Front I/O	1* Power button, 1* Power LED, 1* HDD LED, 2* LAN LED, 2* USB3.1 (Gen.1), 1* AT / ATX mode Switch		
Rear I/O	2* USB3.1 (Gen.1), 2* HDMI, 2* RJ45, 1* MIC/Line-out Combo, 1* COM (RJ45 type), 1* DC jack (locable)		

*The Specification may be changed without further notice.
www.jetwayipc.com

HBFD632-7300-B

Features



- Intel® Skylake/Kabylake U-Series Processor
- 2* DDR4 2133MHz SO-DIMM up to 32GB
- 1* HDMI, 1* DP, 2* RJ45, 4* USB 3.0, 4* USB 2.0, 4* COM (Max.)
- M/B Form Factor : 3.5" (148x102mm)
- DC-12V_60W Adapter



Front IO

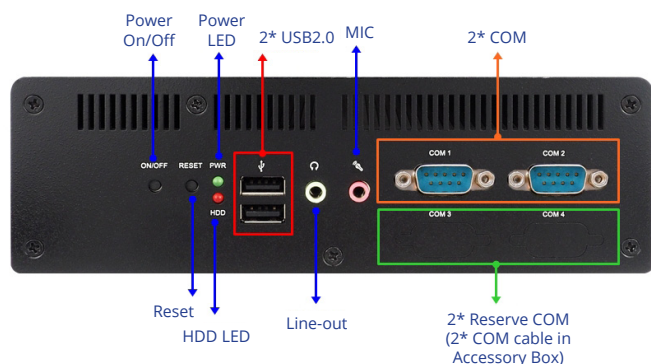

Rear IO

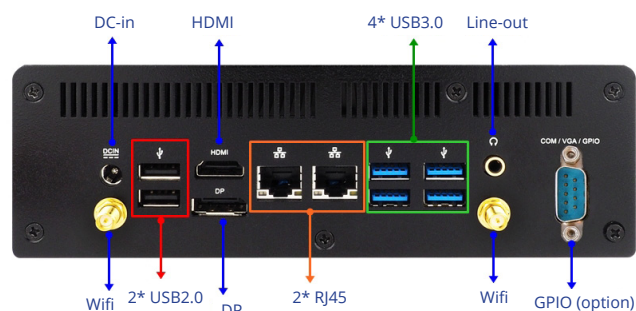

Specifications

Processor	Intel® Skylake/Kabylake U-Series Processor	Power	9~24V DC Power in DC-12V_60W Adapter
Chipset	SoC	Temperature	Operating : 0°C~40°C Storage : -10°C~70°C
Memory	2* DDR4 2133MHz SO-DIMM up to 32GB	Material	Aluminum heatsink &
Ethernet	1* Intel i211AT GbE, 1* Intel i219LM GbE	Structure	steel plane integration structure
Display Output	1* HDMI, 1* DP	Dimension	142.5(D) x 193(W) x 62(H) mm
Storage	1* mSATA (full size shared), 1* 2.5" Device		
Expansion Slot	2* Mini PCI Express (full & half size)		
Front I/O	1* Power LED, 1* HDD LED, 1* Power Button, 1* Reset button, 2* USB 2.0 , 4* COM (Max.), 1* MIC , 1* Line out		
Rear I/O	4* USB 3.0, 2* USB 2.0, 2* RJ45, 1* HDMI, 1* DP, 1* Line out, 1* DC jack		

*The Specification may be changed without further notice.
www.jetwayipc.com

HBFD835-8365-B

Features



- Intel Whiskey Lake-U Processor
- 2* DDR4-2400MHz SO-DIMM up to 32GB
- 2* USB2.0, 4* USB3.1, 1* USB Type-C, 1* HDMI, 1* DP, 2* RJ45
- M/B Form Factor : 3.5" (148x102mm)
- DC-12V_60W Adapter



Front IO

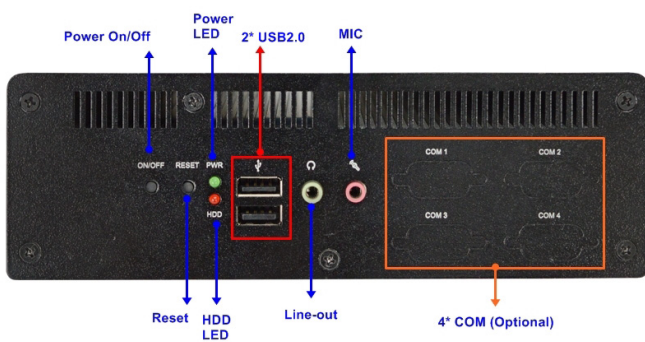

Rear IO

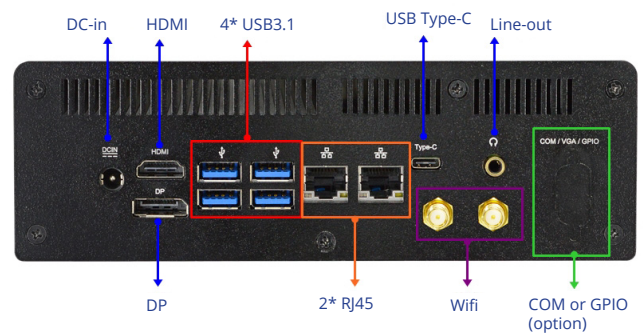

Specifications

Processor	Intel® Whiskey Lake-U SoC Processor	Power	9~24V DC Power in DC-12V_60W Adapter
Chipset	SoC	Temperature	Operating : 0°C~50°C Storage : -20°C~70°C
Memory	2* DDR4-2400MHz SO-DIMM up to 32GB	Material	Aluminum heatsink &
Ethernet	1* Intel i211AT GbE, 1* Intel i219LM GbE	Structure	steel plane integration structure
Display Output	1* HDMI, 1* DP	Dimension	142(D) x 193(W) x 62(H) mm
Storage	1* M.2 M-key (2242/2260/2280) Support PCIex4(NVMe) & SATA interface, 1* 2.5" Device		
Expansion Slot	1* M.2 E-key (2230) Support CNVi		
Front I/O	1* Power button, 1* Reset button, 1* Power LED, 1* HDD LED, 2* USB 2.0, 1* Line-out, 1* MIC-in, 4* COM (optional)		
Rear I/O	4* USB 3.1, 1* USB 3.1(Gen.2) Type C (USB data transfer Only), 1* HDMI1.4, 1* DP, 2* RJ45, 1* Line-out, 1* COM or GPIO (optional), 1* DC-in		

*The Specification may be changed without further notice.
www.jetwayipc.com

HBFD94 Series

Features



- Intel® Apollo Lake J3455 SoC Processor
- 1* DDR3L 1866MHz SO-DIMM up to 8GB
- 1* HDMI, 3* USB2.0, 3* USB3.1, 2* COM, 2* GbE, 1* SIM Card slot
- 9~36V DC input
- DC-12V_60W Adapter



Front IO

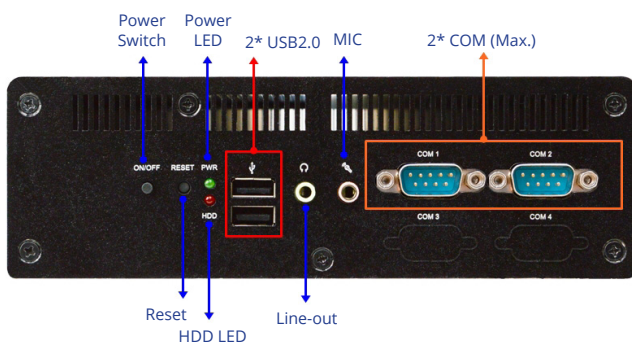

Rear IO

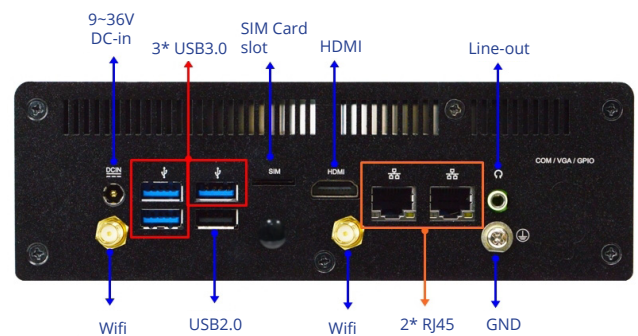

Specifications

Processor	Intel® Apollo Lake Series SoC Processor	Power	9~36V DC input DC-12V_60W Adapter
Chipset	SoC	Temperature	Operating : 0°C~50°C or -40°C~70°C Storage : -20°C~85°C
Memory	1* DDR3L 1866MHz SO-DIMM up to 8GB	Material	All-aluminum body, produced by casting process
Ethernet	2* Intel i211AT GbE	Structure	
Display Output	1* HDMI	Dimension	142.4(D) x 193(W) x 62(H) mm
Storage	1* M.2 (M-key 2242), 1* 2.5" Drive		
Expansion Slot	1* Mini PCI Express (full size), 1* M.2 (B-key 3042)		
Front I/O	1* Power SW, 1* Reset, 1* Power LED, 1* HDD LED, 1* MIC, 1* Line-out, 2* COM (COM1 support RS485), 2* USB2.0		
Rear I/O	2* RJ45, 1* HDMI (Max. Resolution: 3840×2160@ 30Hz), 1* SIM Card slot, 1* Line out (Realtek® ALC662VD), 1* DC-in (9~36V), 1* USB2.0, 3* USB3.1 (Gen.1)		

*The Specification may be changed without further notice.
www.jetwayipc.com

HBFFF793-Q170-B

Features



- Intel LGA 1151 Core i3/i5/i7 Processors(35W)
- 2* DDR4 2133MHz SO-DIMM up to 32GB
- 3* HDMI, 2* RJ45, 4* USB 3.0, 2* USB 2.0, 6* COM
- Support Onboard TPM IC
- M/B Form Factor : Mini ITX (170x170mm)
- 9~24V DC input
- DC-19V_120W Adapter



Front IO

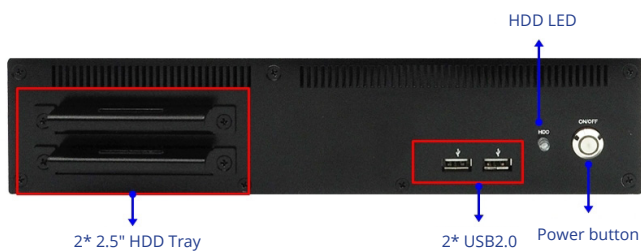

Rear IO

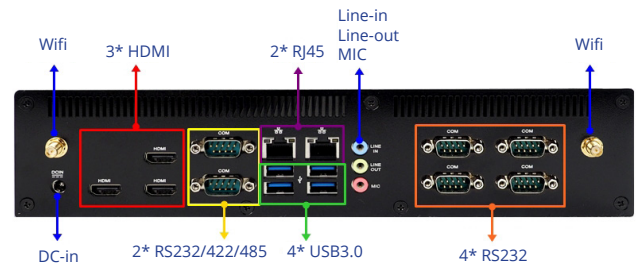

Specifications

Processor	Intel® LGA 1151 Core i3/i5/i7 Processors (35W)	Power	9~24V DC Power in DC-19V_120W Adapter
Chipset	Intel® Q170 chipset	Temperature	Operating : 0°C~50°C Storage : -10°C~70°C
Memory	2* DDR4 2133MHz SO-DIMM up to 32GB	Material	Aluminum heatsink &
Ethernet	1* Intel i211AT & 1* Intel i219LM GbE	Structure	steel plane integration structure
Display Output	3* HDMI	Dimension	207(D) x 290(W) x 65(H) mm
Storage	1* mSATA (full size) 2* 2.5" Device (Easy to change)		
Expansion Slot	1* Mini PCI Express (size helf)		
Front I/O	1* Power LED, 1* HDD LED, 1* Power Button, 2* USB 2.0		
Rear I/O	4* USB 3.0, 2* RJ45, 3* HDMI, 6* COM, 1* Line in, 1* Line out, 1* MIC, 1* DC Jack		

*The Specification may be changed without further notice.
www.jetwayipc.com

HBFFF797-Q370-B

Features



- Intel LGA 1151 8th Gen. Processors (35W)
- 2* DDR4 2666MHz SO-DIMM up to 32GB
- 1* HDMI, 2* DP
- 2* USB2.0, 4* USB3.0, 6* COM (2* RS232/422/485, 4* RS232/option), 2* GbE
- M/B Form Factor : Mini ITX (170x170mm)
- 9~36V DC input
- DC-19V_120W Adapter

Coming Soon

Front IO

Rear IO

Specifications

Processor	Intel® LGA 1151 8th Gen. Processors (35W)	Power	9~36V DC Power in DC-19V Adapter
Chipset	Intel® Q370 chipset	Temperature	Operating : 0°C~60°C Storage : -20°C~85°C
Memory	2* DDR4 2666MHz SO-DIMM up to 32GB	Material	Aluminum heatsink &
Ethernet	1* Intel i211AT, 1* Intel i219LM GbE	Structure	steel plane integration structure
Display Output	1* HDMI, 2* DP		
Storage	1* M.2 (2280)	Dimension	207(D) x 290(W) x 65(H) mm
Expansion Slot	1* M.2 (2230)		
Front I/O	1* Power button, 2* USB2.0, 2* 2.5" HDD tray		
Rear I/O	4* USB3.0, 6* COM (2* RS232/422/485, 4* RS232/option), 1* LineOUT, 1* Mic, 2* RJ45, 1* HDMI, 2* DP		

*The Specification may be changed without further notice.
www.jetwayipc.com

HM-1300

Features



- Intel LGA 1151 Core i3/i5/i7 Processors (45W)
- 2* DDR4 2133MHz SO-DIMM up to 32GB
- Support 1* PCIe x16 slot, 2* PCI slot
- Scalability & DC 9~36V IN - wide input voltage
- Form Factor : 212x150x220mm
- DC-19V_120W Adapter



Rear IO

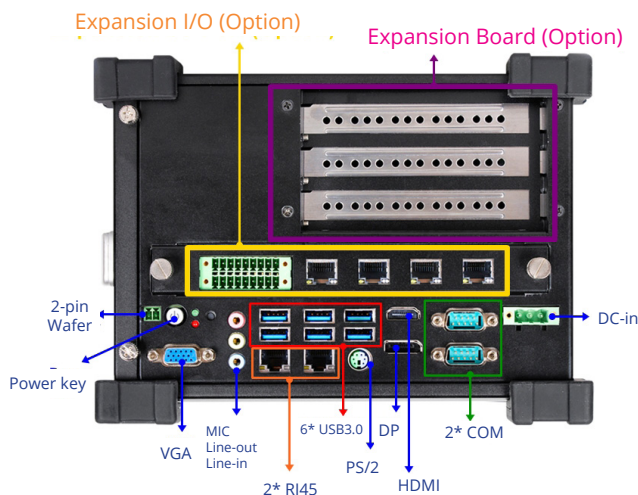

Specifications

Processor	Intel® LGA 1151 Core i3/i5/i7 Processors (45W)	Power	9~36V DC Power in Phoenix terminal-3 PIN
Chipset	Intel® Q170 chipset	Temperature	Operating : -10°C~60°C Storage : -20°C~70°C
Memory	2* DDR4 2133MHz SO-DIMM up to 32GB	Material	Aluminum heatsink &
Ethernet	1* Intel i211AT & 1* Intel i219LM GbE	Structure	steel plane integration structure
Display Output	1* VGA, 1* HDMI, 1* DP	Dimension	212(D) x 150(W) x 220(H) mm
Storage	1* M.2 (2260/2280), 1* 2.5" Device		
Expansion Slot	1* Mini PCI Express (full size), 1* PCI Express x 16 Slots, 2* PCI Slots		
Front I/O	N/A		
Rear I/O	1* Power Button, 1* Reset button, 1* Power LED, 1* HDD LED, 1* VGA, 2* RJ45, 4* USB 3.0, 2* USB 2.0, 1* HDMI, 1* DP, 2* COM, 1* PS/2, 1* Line in, 1* Line out, 1* MIC, 1* DC in Connector, 1* FP Power Connector		

*The Specification may be changed without further notice.
www.jetwayipc.com

HM-2000

Features



- Intel® Apollolake J3455 Processor
- Onboard 4G DDR3L 1600MHz up to 8GB
- 1* HDMI, 1* VGA, 2* RJ45, 4* USB 3.0, 4* USB 2.0, 20* COM, 16-bits GPIO
- M/B Form Factor : 223x170x127.5mm
- DC-12V_5A_60W Adapter



Rear IO

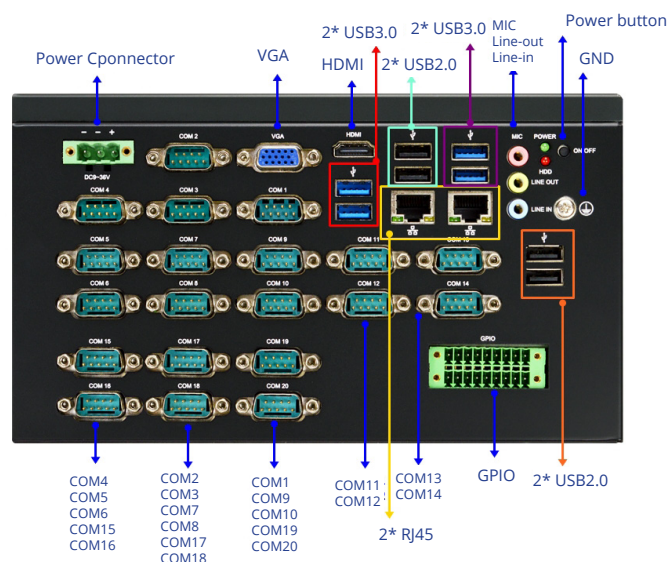

Specifications

Processor	Intel® Apollolake J3455 Processor	Power	9~36V DC Power in Phoenix terminal-3 PIN
Chipset	SoC	Temperature	Operating : -10°C~60°C Storage: -20°C~70°C
Memory	Onboard 4G DDR3L 1600MHz up to 8GB	Material	Aluminum heatsink &
Ethernet	2* Intel i211AT GbE	Structure	steel plane integration structure
Display Output	1* VGA, 1* HDMI	Dimension	223(D) x 170(W) x127.5(H) mm
Storage	1* M.2 (2242/2260/2280), 1* 2.5" Device		
Expansion Slot	1* Mini PCI Express (full size)		
Front I/O	N/A		
Rear I/O	1* Power Button, 1* Power LED, 1* HDD LED, 1* HDMI, 1* VGA, 2* RJ45, 4* USB 3.0, 4* USB 2.0, 20* COM, 1* Line in, 1* Line out, 1* MIC, 1* 16-bits GPIO, 1* DC in Connector		

*The Specification may be changed without further notice.
www.jetwayipc.com

HM-3000

Features



- Intel® LGA 1151 Core i3/i5/i7 Processors (45W)
- 2* DDR4 2133MHz SO-DIMM up to 32GB
- 1* HDMI, 1* VGA, 2* RJ45, 4* USB 3.0, 2* USB 2.0, 2* RS232/422/485, 1* Audio
- Form Factor : 212x131x220mm
- DC-19V_120W Adapter



Rear IO

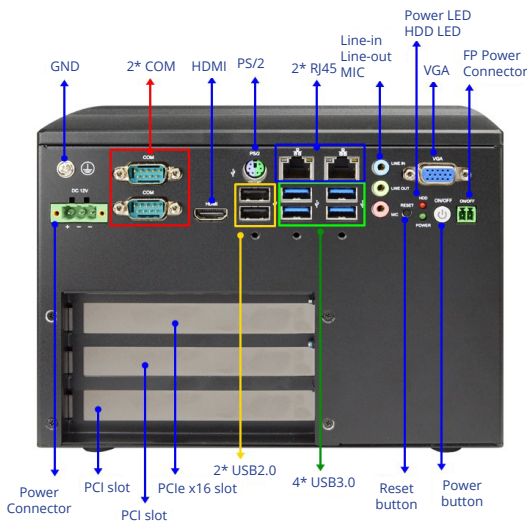

Rear IO



Specifications

Processor	Intel® LGA 1151 Core i3/i5/i7 Processors(45W)	Power	19V DC Power in Phoenix terminal-3 PIN
Chipset	Intel® H110 chipset	Temperature	Operating : -10°C~60°C Storage : -20°C~70°C
Memory	2* DDR4 2133MHz SO-DIMM up to 32GB	Material	Aluminum heatsink &
Ethernet	1* Intel i211AT & 1* Intel i219LM GbE	Structure	steel plane integration structure
Display Output	1* VGA, 1* HDMI	Dimension	212(D) x 131(W) x 220(H) mm
Storage	1* mSATA (full size shared), 1* 2.5" Device		
Expansion Slot	1* Mini PCI Express (full size), 1* PCI Express x 16 Slots, 2* PCI Slots		
Front I/O	N/A		
Rear I/O	1* Power Button, 1* Reset button, 1* Power LED, 1* HDD LED, 1* VGA, 2* RJ45, 4* USB 3.0, 2* USB 2.0, 1* HDMI, 2* COM, 1* PS/2, 1* Line in, 1* Line out, 1* MIC, 1* DC in Connector, 1* FP Power Connector		

*The Specification may be changed without further notice.
www.jetwayipc.com

HM-5000

Features



- Intel® Whiskey lake U series Processor
- 2* DDR4 2400/2133HMz SO-DIMM up to 32GB
- 1* HDMI, 1* DP
- 2* RS232/422/485, 2* GbE, 4* PoE,
- 1* GPIO, 2* USB3.0, 2* USB2.0
- 9~36V DC input



Front IO

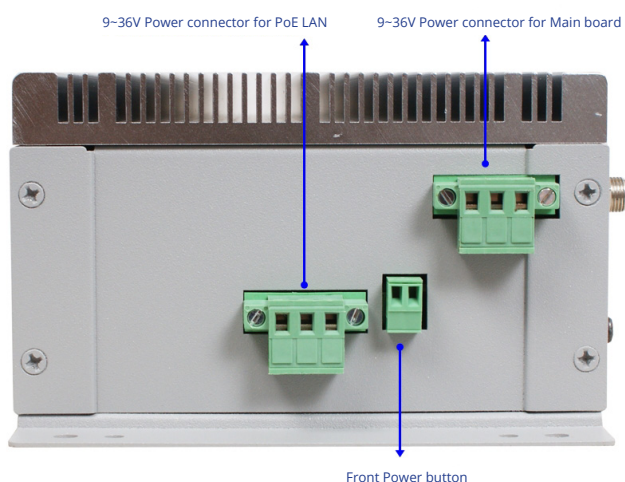

Rear IO

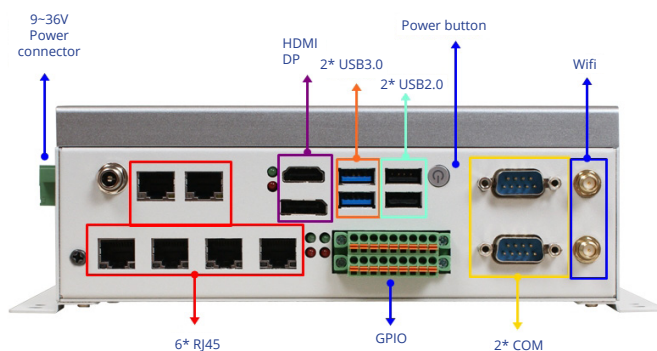

Specifications

Processor	Intel® Whiskey lake U series Processor	Power	9~36V DC Power in DC-12V_60W Adapter
Chipset	SoC	Temperature	Operating : 0°C~50°C Storage : -10°C~70°C
Memory	2* DDR4 2400/2133HMz SO-DIMM up to 32GB	Material	Aluminum heatsink &
Ethernet	1* Intel i219LM GbE, 1* Intel i211AT GbE, 4* PoE	Structure	steel plane integration structure
Display Output	1* HDMI, 1* DP	Dimension	142(D) x 185(W) x 48(H) mm
Storage	1* M.2 (M-key-2242, 2280), 1* 2.5" Device		
Expansion Slot	1* M.2 (E-key 2230), 1* M.2 (B-key 3042, 3052)		
Front I/O	Side: 1* 3-pin terminal block for Main board, 1* 3-pin terminal block for 4* PoE, 1* 2-pin power connector		
Rear I/O	1* HDMI, 1* DP, 2* RS232/422/485, 2* GbE, 4* PoE, 1* GPIO, 2* USB3.0, 2* USB2.0, 1* power button		

*The Specification may be changed without further notice.
www.jetwayipc.com

HBJC923R3328DG2NL

Features



- Rockchip® A53 RK3328 Quad-core 1.5GHz
- Onboard DR3L 1333MHz 2GB DRAM
- 8G Flash ROM (Max. 32GB)
- Support 1* GbE and 1* 10/100M LAN
- 1* Micro SD Socket (Max 64G), 2* USB2.0,
- 1* OTG/DC-in, 1* HDMI, 1* Line-out
- Support Android 7.1
- 5V DC-in



Front IO

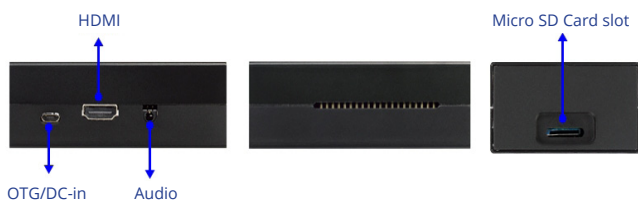

Rear IO

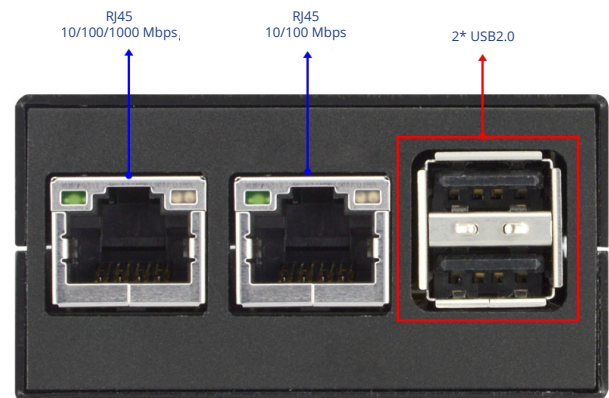

Specifications

Processor	Rockchip® ARM Cortex A53 RK3328 SoC Processor	Power	AC 100~240V input DC 5V-15W Adapter
Chipset	Rockchip® RK3328 SoC	Temperature	Operating : -10°C~60°C Storage : -20°C~65°C
Memory	DDR3L 1333MHz 2GB	Material	Aluminum
Ethernet	1* Realtek RTL8211F-CG GbE, 1* internal FE PHY	Structure	
Display Output	1* HDMI	Dimension	60.5(D) x 94.4(W) x 33.6(H) mm
Storage	8GB Flash (Max. 32GB)		
Expansion Slot	N/A		
Front I/O	N/A		
Rear I/O	2* USB2.0, 1* Line-out, 2* RJ45, 1* HDMI, 1* OTG/5V DC-in, 1* Micro SD Socket		

*The Specification may be changed without further notice.
www.jetwayipc.com

HBJC923R3328DG2NS

Features



- Rockchip® A53 RK3328 Quad-core 1.5GHz
- Onboard DDR3L 1333MHz 2GB DRAM
- 8G Flash ROM (Max. 32GB)
- Support 1* GbE, 1* Micro SD Socket (Max 64G), 1* USB3.0, 2* USB2.0, 1* OTG/DC-in, 1* HDMI, 1* Line-out
- Support Android 7.1
- 5V DC-in



Front IO



Rear IO

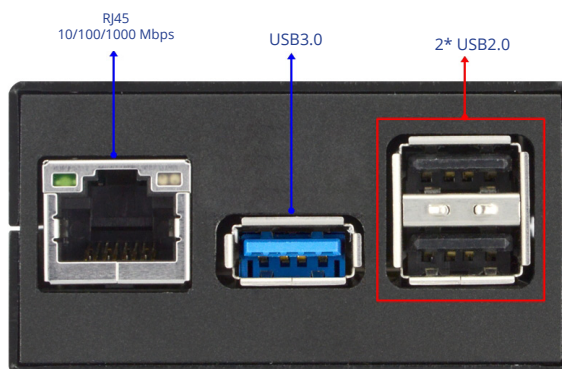

Specifications

Processor	Rockchip® ARM Cortex A53 RK3328 SoC Processor	Power	AC 100~240V input DC 5V_15W Adapter
Chipset	Rockchip® RK3328 SoC	Temperature	Operating : -10°C~60°C Storage : -20°C~65°C
Memory	DDR3L 1333MHz 2GB	Material	Aluminum
Ethernet	1* Realtek RTL8211F-CG GbE	Structure	
Display Output	1* HDMI	Dimension	60.5(D) x 94.4(W) x 33.6(H) mm
Storage	8GB Flash (Max. 32GB)		
Expansion Slot	N/A		
Front I/O	N/A		
Rear I/O	1* USB3.0, 2* USB2.0, 1* Line-out, 1* RJ45, 1* HDMI, 1* OTG/5V DC-in, 1* Micro SD Socket		

*The Specification may be changed without further notice.
www.jetwayipc.com

HBJC924R3288DG2NS

Features



- Rockchip® ARM Cortex A17 RK3288 Quad-core 1.8GHz
- Onboard DDR3L 1333MHz 2GB SDRAM
- Onboard 8G Flash ROM up to 64GB
- 1* Realtek® GbE, 1* 802.11b/g/n 2.4G WIFI and BT-V4.0
- 1* Micro SD(Max. 64G), 4* USB2.0, 1* OTG, 1* GPIO, 1* HDMI, 1* Audio
- Support Android 5.1, Linux Debian 9.0
- 5V DC-in

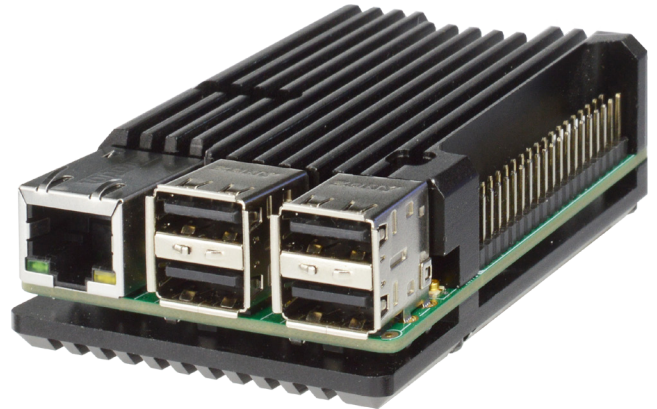

Front IO

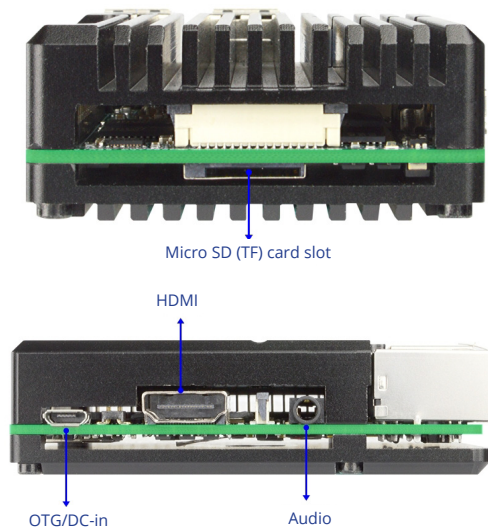

Rear IO

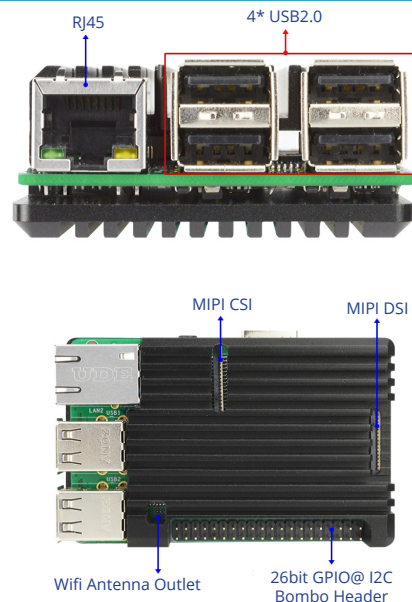

Specifications

Processor	Rockchip® ARM Cortex A17 RK3288 Processor	Power	100~240V AC Power in DC-5V_15W Adapter
Chipset	Rockchip® RK808-B	Temperature	Operating : -10°C~60°C Storage : -20°C~65°C
Memory	Onboard DDR3L 1333MHz 2GB SDRAM	Material	Aluminum
Ethernet	1* REALTEK RTL8211E-VB GbE	Structure	
Display Output	1* HDMI	Dimension	56(D) x 87(W) x 22.9(H) mm
Storage	8GB Flash (Max 64GB)		
Expansion Slot	N/A		
Front I/O	1* OTG / DC Jack, 1* HDMI, 1* Audio		
Rear I/O	1* RJ45, 4* USB2.0, 1* Micro SD Socket (Front) Internal: 26bit GPIO, 1* I2C, 1* MIPI DSI, 1* MIPI CSI		

*The Specification may be changed without further notice.
www.jetwayipc.com



捷波資訊股份有限公司
JETWAY INFORMATION CO., LTD.

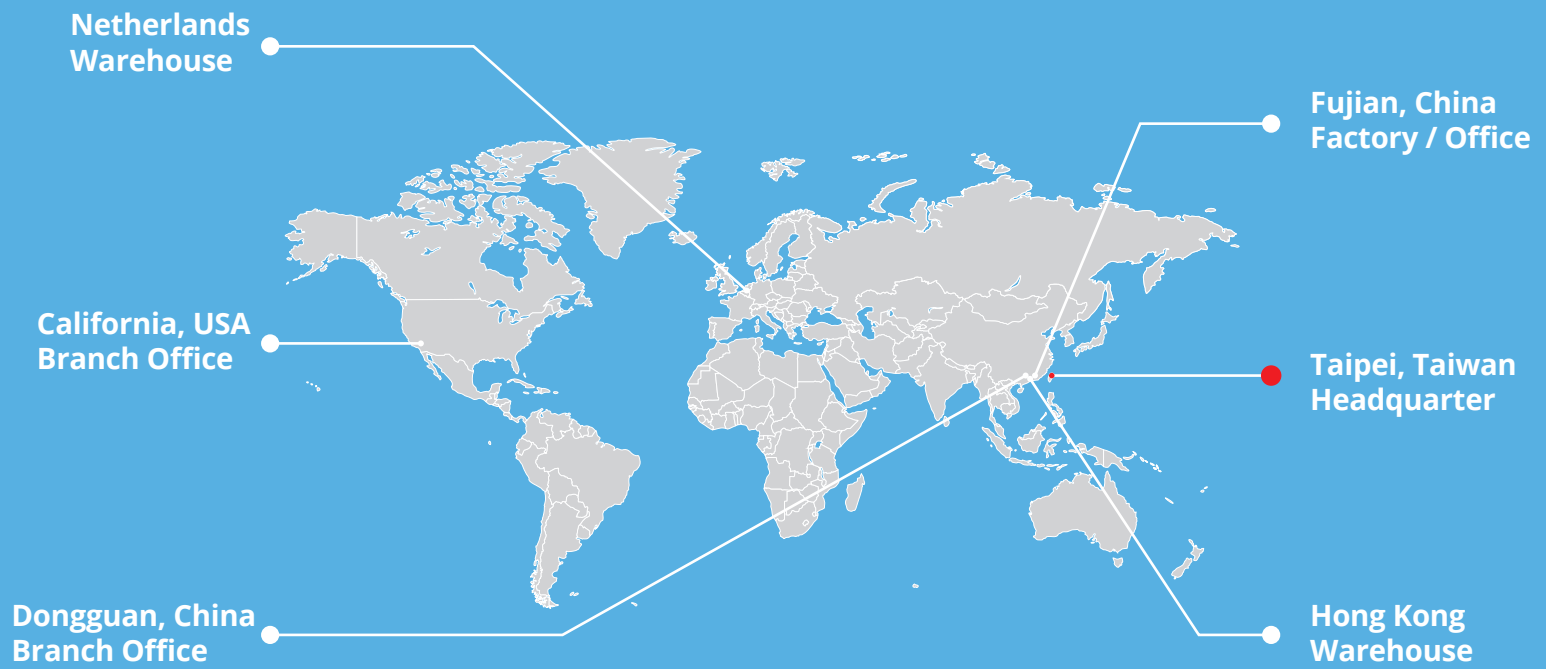

Taiwan (Taipei)

9F., No. 207, Sec. 3, Beixin Rd.,
Xindian Dist., New Taipet City, 23143,
Taiwan (R.O.C)
Tel: +886-2-89132711
Fax: +886-2-89132722

China (Dongguan)

No. 605, 8th Commercial Office Building,
Vanke Center, Changqing South Road,
Changan, Dongguan City, 523850, China
Tel: +86-769-2101-8010
Mobile : +86-138-2880-2876

Factory (Fujian)

North Industrial Park, Changshan Economic
Development Zone, Yunxiao County,
Zhangzhou, Fujian Provice 363307, China
Tel: +86-596-8625168

All brand names and products are registered trademarks of their respective companies.



Z-A121-F

